

LBC3094/15 Sound projector loudspeaker, 10W

www.boschsecurity.com



BOSCH
Invented for life



- ▶ Suitable for speech and music reproduction
- ▶ Simple power setting
- ▶ 2 m fixed connection cable
- ▶ Splash-waterproof
- ▶ Robust self-extinguishing ABS enclosure to UL 94 V0

The LBC 3094/15 is a sound projector for speech and background music reproduction in indoor or outdoor applications such as shopping centers, factory grounds and sports fields.

Functions

Sound projectors are intended for applications where directing the sound beam is desirable. Similar in concept to a spotlight, a sound projector can be used to provide localized sound reproduction. Typical examples include restaurants, exhibitions, factory grounds and shopping centers.

The sound projectors are splash waterproof and suitable for outdoor use and in environments with high humidity levels.

The enclosures are made from high-impact self-extinguishing ABS (acc. to class UL 94 V0). The sound projector enclosures are colored white and supplied with steel mounting brackets painted in white. They are suitable for mounting onto walls or ceilings.

Certifications and approvals

All Bosch loudspeakers are designed to withstand operating at their rated power for 100 hours in accordance with IEC 268-5 Power Handling Capacity (PHC) standards. Bosch has also developed the Simulated Acoustical Feedback Exposure (SAFE) test to demonstrate that they can withstand two times their rated power for short durations. This ensures extra reliability under extreme conditions, leading to higher customer satisfaction, longer operating life, and much less chance of failure or performance deterioration.

All plastic parts are manufactured from self-extinguishing high-impact ABS material (according to UL 94 V0). In common with all Bosch products, care is taken to meet high safety standards. These sound projectors comply with all the relevant safety and installation regulations of EN 60065.

Water and dust protection

acc. to EN 60529, IP 63

Region	Regulatory compliance/quality marks	
Europe	CE	
	CE	DECL IP LBC3094_15

Installation/configuration notes

All units are supplied with a color-coded four-core connecting cable with each color connected to a different primary tap on the 100 V matching transformer. This allows nominal full-power, half-power or quarter-power radiation to be selected (in 3 dB steps).

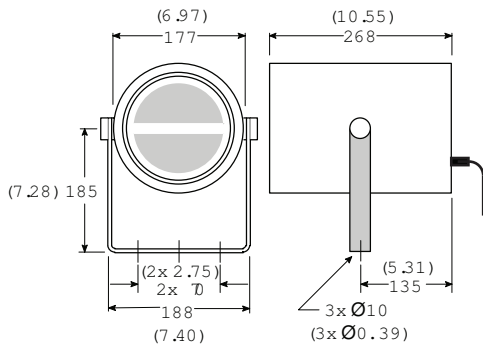

Dimensions in mm (in)

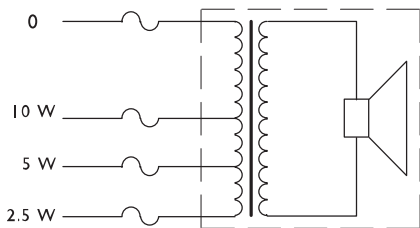

Circuit diagram

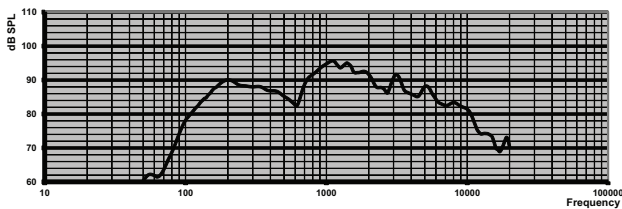

Frequency response

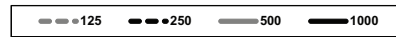
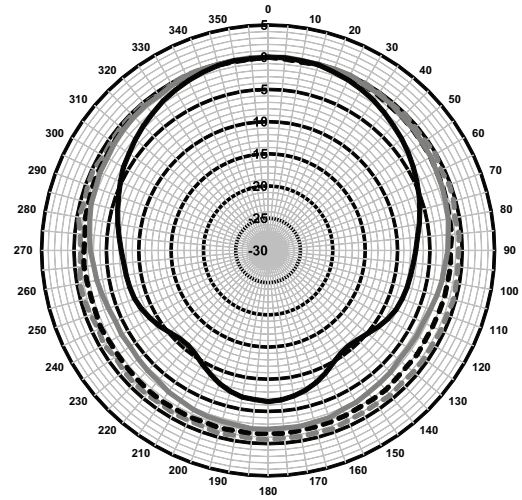

Polar diagram (measured with pink noise)

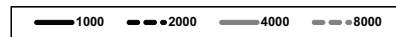
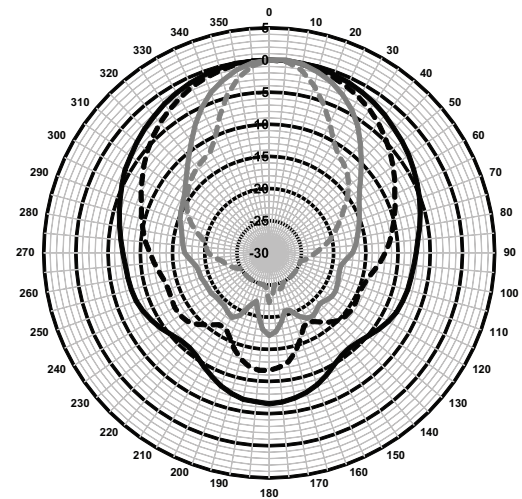

Polar diagram (measured with pink noise)

Octave band sensitivity*

	Octave SPL 1W/1m	Total octave SPL 1W/1m	Total octave SPL Pmax/1m
125 Hz	84.7	-	-
250 Hz	88.4	-	-
500 Hz	85.7	-	-
1000 Hz	94.0	-	-
2000 Hz	91.6	-	-
4000 Hz	88.9	-	-
8000 Hz	84.1	-	-

A-weighted	-	87.7	97.1
Lin-weighted	-	88.1	97.6

Octave band opening angles

	Horizontal	Vertical	
125 Hz	360	360	
250 Hz	360	360	
500 Hz	360	360	
1000 Hz	152	152	
2000 Hz	106	106	
4000 Hz	60	60	
8000 Hz	38	38	

Acoustical performance specified per octave * (all measurements are done with a pink noise signal, the values are in dBSPL).

Parts included

Quantity	Component
1	LBC 3094/15 Sound Projector

Technical specifications

Electrical*

Maximum power	15 W
Rated power (PHC)	10 W
Power tapping	10 / 5 / 2.5 W
Sound pressure level at 10 W / 1 W (1 kHz, 1 m)	104 dB / 94 dB (SPL)
Effective frequency range (-10 dB)	140 Hz to 10 kHz
Opening angle at 1 kHz / 4 kHz (-6 dB)	152° / 60°
Rated input voltage	100 V
Rated impedance	1000 ohm
Electrical connection	2 m (78.74 in) 4-core fixed cable

* Technical performance data acc. to IEC 60268-5

Mechanical

Dimensions (D x L)	177 x 268 mm (6.97 x 10.55 in)
Weight	2.2 kg (4.8 lb)
Color	White (RAL 9010)
Material:	

Enclosure	ABS
Bracket	Steel

Environmental

Operating temperature	-25 °C to +55 °C (-13 °F to +131 °F)
Storage and transport temperature	-40 °C to +70 °C (-40 °F to +158 °F)
Relative humidity	<95%

Ordering information

LBC3094/15 Sound projector loudspeaker, 10W

Sound projector 10 W, white ABS enclosure, water and dust protected IP63, fixed 2 m connection cable. Order number **LBC3094/15**

Accessories

LBC1256/00 Ceramic connection adapter

Emergency connection adapter, 3-pole screw ceramic connector with a pre-mounted thermal fuse, to be installed in series with the 100 V primary connection of a loudspeaker unit, set of 100 pieces. Order number **LBC1256/00**

Represented by:

Europe, Middle East, Africa:
Bosch Security Systems B.V.
P.O. Box 80002
5600 JB Eindhoven, The Netherlands
Phone: + 31 40 2577 284
emea.securitysystems@bosch.com
emea.boschsecurity.com

Germany:
Bosch Sicherheitssysteme GmbH
Robert-Bosch-Ring 5
85630 Grasbrunn
Germany
www.boschsecurity.com

North America:
Bosch Security Systems, Inc.
130 Perinton Parkway
Fairport, New York, 14450, USA
Phone: +1 800 289 0096
Fax: +1 585 223 9180
onlinehelp@us.bosch.com
www.boschsecurity.us

Asia-Pacific:
Robert Bosch (SEA) Pte Ltd, Security Systems
11 Bishan Street 21
Singapore 573943
Phone: +65 6571 2808
Fax: +65 6571 2699
apr.securitysystems@bosch.com
www.boschsecurity.asia