



# PLENA matrix

Public Address system



**BOSCH**



## Table of contents

<b>1</b>	<b>Safety</b>	<b>5</b>
1.1	FCC and ICES	5
<b>2</b>	<b>About this manual</b>	<b>7</b>
2.1	Manual purpose	7
2.2	Digital document	7
2.3	Intended audience	7
2.4	Alerts and notice signs	7
2.5	Copyright and disclaimer	7
2.6	Document history	8
<b>3</b>	<b>System overview</b>	<b>9</b>
3.1	Application area	11
3.2	Scope of delivery	11
<b>4</b>	<b>Planning</b>	<b>12</b>
<b>5</b>	<b>Installation</b>	<b>13</b>
5.1	DSP Matrix Mixer and Amplifiers	13
5.2	Call Station	14
5.3	Wall Control Panel	15
5.4	PC GUI software	16
5.4.1	PC requirements	16
5.4.2	PC GUI application software installation	16
5.5	iOS GUI software	17
<b>6</b>	<b>Connections</b>	<b>18</b>
6.1	Call Station	18
6.2	Wall Control Panel	18
6.3	Multi channel DSP Amplifier	19
6.4	DSP Matrix Mixer	21
<b>7</b>	<b>Configuration</b>	<b>23</b>
7.1	Call Station	23
7.1.1	Call Station DIP switch settings	23
7.2	Wall Control Panel DIP switch settings	24
7.3	Multi Channel DSP Amplifier settings	25
7.4	DSP matrix mixer PC GUI	26
7.5	Multi Channel DSP Amplifier PC GUI	28
7.5.1	Amplifier Bridging Configuration	31
<b>8</b>	<b>Operation</b>	<b>32</b>
8.1	Start	32
8.2	Call Station	33
8.2.1	Pre-settings and selections	34
8.2.2	Making an announcement	34
8.3	Wall Control Panel	35
8.3.1	Select the input source	36
8.3.2	Adjust the audio output volume level	36
8.4	Multi Channel DSP Amplifier	37
8.4.1	Activate the active override audio input function	38
8.4.2	Activate the amplifier auto standby	38
8.4.3	Operate the amplifier with the PC GUI	38
8.5	DSP Matrix Mixer	39

---

8.5.1	Activate the override input function	40
8.5.2	Activate the Alert/EVAC override function	40
8.5.3	Operating the DSP Matrix Mixer/system with the GUI	40
<b>9</b>	<b>Troubleshooting</b>	<b>41</b>
9.1	Customer service	44
<b>10</b>	<b>Maintenance</b>	<b>45</b>
10.1	Clean the units	45
10.2	Clean air vents	45
10.3	Check the connectors and grounding	45
<b>11</b>	<b>Technical Data</b>	<b>46</b>
11.1	Electrical	46
11.1.1	DSP Matrix Mixer	46
11.1.2	Multi Channel DSP Amplifier	47
11.1.3	Call Station	49
11.1.4	Wall Control Panel	49
11.2	Mechanical	50
11.2.1	DSP Matrix Mixer	50
11.2.2	Multi Channel DSP Amplifier	50
11.2.3	Call Station	50
11.2.4	Wall Control Panel	51
11.3	Environmental conditions	52
11.3.1	DSP Matrix Mixer	52
11.3.2	Multi Channel DSP Amplifier	52
11.3.3	Call Station	52
11.3.4	Wall Control Panel	52
11.4	Standards	52

# 1 Safety

Prior to installing or operating products, always read the Important Safety Instructions which are available as a separate multilingual document: Important Safety Instructions (Safety\_ML). These instructions are supplied together with all equipment that can be connected to the mains supply.

## Safety precautions

The DSP matrix mixer and the DSP amplifiers are designed to be connected to the public distribution network.

- To avoid any risk of electric shock, all interventions must be carried out with disconnected mains supply.
- The ventilation should not be impeded by covering the ventilation openings with items such as news papers, table cloths or curtains.
- Connection of external wiring to this equipment requires installation by qualified personnel only.
- The operation must only be performed by qualified personnel.
- Use the apparatus in moderate climate.



### Caution!

These service instructions are for use by qualified service personnel only.

To reduce the risk of electric shock, do not perform any servicing other than that contained in the operating instructions unless you are qualified to do so.

## 1.1

### FCC and ICES

*(U.S.A. and Canadian models only)*



#### Business Equipment

**For commercial or professional use**



### Warning!

This equipment has been tested and found to comply with the limits for a Class A digital device, pursuant to Part 15 of the FCC Rules and ICES-003 of Industry Canada. These limits are designed to provide reasonable protection against harmful interference when the equipment is operated in a commercial environment. This equipment generates, uses, and can radiate radio frequency energy and, if not installed and used in accordance with the instruction manual, may cause harmful interference to radio communications. Operation of this equipment in residential area is likely to cause harmful interference in which case the user will be required to correct the interference at his own expense. Intentional or unintentional changes or modifications not expressly approved by the party responsible for compliance shall not be made. Any such changes or modifications could void the user's authority to operate the equipment.

If necessary, the user should consult the dealer or an experienced radio/ television technician for corrective action. The user may find the following booklet prepared by the Federal Communications Commission helpful: "How to identify and Resolve Radio-TV Interference Problems". This booklet is available from the U. S. Government Printing Office, Washington, DC 20402, Stock No. 004-000-00345-4.



**Warning!**

This is a Class A product. In a domestic environment this product may cause radio interference in which case the user may be required to take adequate measures.

---

## 2 About this manual

Please read this manual carefully before installing and operating any of the PLENA matrix public address products and retain it for future reference.

### 2.1 Manual purpose

The purpose of this manual is to provide information required for installing, configuring, operating and maintaining the PLENA matrix public address Hardware products. For instructions on the latest PC GUI software, please download the software from the product related information on the [www.boschsecurity.com](http://www.boschsecurity.com) website.

### 2.2 Digital document

This manual is available as a digital document in the Adobe Portable Document Format (PDF). Refer to the product related information on [www.boschsecurity.com](http://www.boschsecurity.com).

### 2.3 Intended audience

This manual is intended for installers, operators and users of a PLENA matrix public address system.

### 2.4 Alerts and notice signs

Four types of signs can be used in this manual. The type is closely related to the effect that may be caused if it is not observed. These signs - from least severe effect to most severe effect - are:



#### Notice!

Containing additional information. Usually, not observing a 'notice' does not result in damage to the equipment or personal injuries.



#### Caution!

The equipment or the property can be damaged, or persons can be lightly injured if the alert is not observed.



#### Warning!

The equipment or the property can be seriously damaged, or persons can be severely injured if the alert is not observed.



#### Danger!

Not observing the alert can lead to severe injuries or death.

### 2.5 Copyright and disclaimer

All rights reserved. No part of this document may be reproduced or transmitted in any form by any means, electronic, mechanical, photocopying, recording, or otherwise, without the prior written permission of the publisher. For information on getting permission for reprints and excerpts, contact Bosch Security Systems B.V..

The content and illustrations are subject to change without prior notice.

## 2.6 Document history

Release date	Documentation version	Reason
2013.06.18	V1.0	- 1 <sup>st</sup> Edition.



### 3 System overview

The Bosch PLENA matrix product range consists of high-quality products and is the ideal solution to perform zone announcements, with excellent speech intelligibility and background music, in a wide variety of public address areas.

The system is designed for maximum flexibility to suit almost any application. The installation of is quick and easy, because the system uses CAT-5 cables to connect accessories and amplifiers to the DSP matrix mixer.

#### **PLENA matrix product range comprises:**

##### **– PLM-8M8 – 8 Channel DSP Matrix Mixer:**



The digital signal processor (DSP) Matrix Mixer is the heart of the PLENA matrix system. When combined with the Call Station (PLM-8CS) and the Wall Control Panel (PLM-WCP) making announcements and controlling individual zones is easy. The multi channel DSP amplifiers (PLM-4Px2x) can be connected via STP type CAT-5 (Amp Link) or via phoenix terminal connectors. The internal audio matrix can control announcements (via the call station), mix four mic./line inputs, and select any of the three background music sources and deliver these to a total of eight independent zone outputs. There is also a logic input for emergency override that will take priority over all other inputs. Control of the DSP features is via Ethernet connection and use of the product GUI of Windows or iPad.

##### **– PLM-4P125 and PLM-4P220 – Multi channel DSP Amplifiers:**



With the exception of the power output, both Class-D multi channel DSP Amplifiers are virtually identical in features. The amplifiers come with advanced DSP features which are accessed by the PC GUI. Both amplifiers feature the “Amp Link” CAT-5 cable connection to connect easily to the PLM-8M8 DSP Matrix Mixer. Loudspeaker outputs are for 100 V, 70 V, 8 Ohm and 4 Ohm operation. The amplifier channels can also be bridged together to make more powerful outputs. The amplifiers also feature an auto standby mode that significantly reduces the power consumption making the amplifiers more cost effective and environmentally friendly.

– **PLM-8CS – 8 Zone Call Station:**



The 8 Zone Call Station is used to make announcements in designated zone configurations. A total of 8 call groups can be configured in the DSP Matrix Mixer and activated via the capacitive touch areas on the surface. The call station is powered via the PLM-8M8 DSP Matrix Mixer over standard CAT-5 cables. The control is over the RS485 protocol, and can be looped-through to add more call stations to the system.

– **PLM-WCP – Wall Control Panel:**



The Wall Control Panel is used to select and control the volume of input sources within in a particular zone. The unit can set up to either; select the background music (BGM) input source, or to mix the four mic./line input sources within a zone. The connection uses the same CAT-5 cabling and RS485 protocol as the PLM-8CS 8 Zone Call Station and is also powered via the PLM-8M8 DSP Matrix Mixer. Installation of the wall control panel is via the supplied wall-mount bracket.

– **PC Configuration and User GUI:**

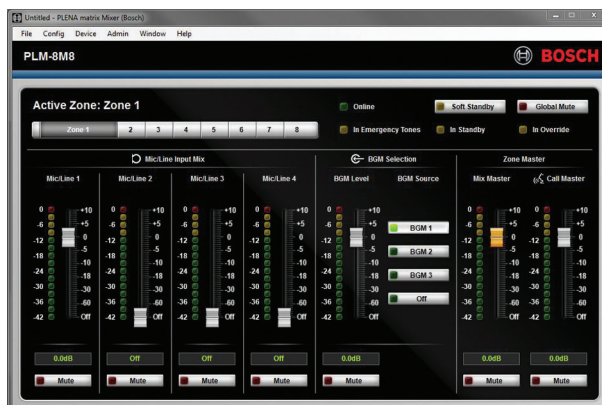

The PC GUI offers a configuration page and user operation page to setup and control the PLM-8M8 DSP Matrix Mixer and also the PLM-4Px2x Amplifiers. The software GUIs are able to be downloaded from the Bosch website: [www.boschsecurity.com](http://www.boschsecurity.com).

### 3.1 Application area

The PLENA matrix product range is designed to be used in small to medium-sized public address application areas, such as; hotels, shops, supermarkets, restaurants, bars, canteens, gyms, showrooms, regional airports, warehouses, educational facilities, theatres-back of house, and other places where announcements and background music (BGM) creates the right atmosphere.

### 3.2 Scope of delivery

Make sure that the following items are included with your product:

- **PLM-8M8 – 8 Channel DSP Matrix Mixer:**
  - 1x Safety instructions.
  - 1x Mains power cord.
  - 1x Set of 19”mounting brackets.
- **PLM-4Px2x – Multi Channel DSP Amplifiers:**
  - 1x Safety instructions.
  - 1x Mains power cord.
  - 2x 12-pole euro/phoenix connectors.
  - 2x 4-pole euro/phoenix connectors.
  - 1x 1 m 26AWG x 4-pair shielded CAT-5e cable.
  - 1x Set of 19”mounting brackets.
- **PLM-8CS – 8 Zone Call Station:**
  - N/A.
- **PLM-WCP – Wall Control Panel:**
  - 1x Wall mount bracket.

## 4 Planning

Make sure that:

- You make use of manufacturer specified installation materials.
- No liquids can spill into or on the products.
- Installation is in a clean environment free of dust and belly button lint.
- The ventilation airflow of the 19" units is not obstructed.
- There is a mains power outlet of sufficient rating close to the intended location of the products.
- Sufficient free space and access at the rear of the 19" units for connectors and wiring.
- Check you have downloaded the latest versions of documentation and software from the Bosch website: [www.boschsecurity.com](http://www.boschsecurity.com).

## 5 Installation

Hardware and software installation procedures are described in the following chapters. Before installing the rack mounted products:

1. Set the mains power switch on the unit's rear panel to the off position:
  - The DSP matrix mixer unit and multi channel DSP amplifier operates on AC mains voltage ranging from 100-240VAC, 50-60Hz.

### 5.1 DSP Matrix Mixer and Amplifiers

The DSP matrix mixer and the multi channel DSP amplifiers are designed for installation into a 19" rack. For 19" rack installation; use:

- The 19" rack mounting brackets which come with the product.
- Standard M6 mounting screws: 16 mm thread depth, 20 mm total length.

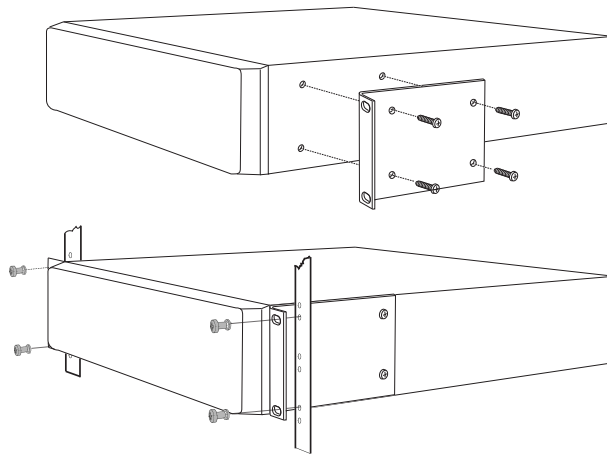

Figure 5.1: 19" bracket and rack mounting



#### Notice!

If you install the product into a 19" rack:

- Ensure that it does not exceed the overheating temperature (+45°C ambient).
- Use the included Bosch 19" mounting brackets.

## 5.2

### Call Station

1. A call station is used as a desktop device. As such be careful do not place this product where it is likely to have liquid spilt on it.
2. Take care to when installing not to exceed the cable manufactures' "bend radius" specifications.
3. Be sure that cabling is installed in a way that the cabling will not be damaged, and it will not become a hazard.
4. Check that RJ45 connectors have strong locking tabs, and are not able to be inadvertently pulled out once installed. Refer to *Call Station, page 18*.

---

#### Notice!



The maximum number of call station IDs that can be configured for each DSP matrix mixer is 8 call stations.

The maximum safe cable distance from the DSP matrix mixer to the last call station on is 500m. This may be extended with the use of better cable and less call stations on that cable run.

If the cables are exposed; use black CAT-5 cables. This makes for a better visual look once installed, as it matched the black of the call station.

---

## 5.3 Wall Control Panel

A wall control panel is installed as a wall/surface mount product that allows two methods of cable entry. This allows the same product to be used for both; solid masonry walls, where cables are often run externally down a wall, then enter the unit from above; or alternatively on frame constructions where cables are inside the cavity and need to be hidden.

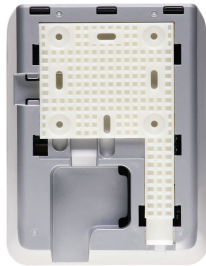

1. Be sure to plan for easy cable entry into unit before affixing the bracket to the surface:
  - Be sure that there are no electrical cables that will be obstructed or compromised by the method of fixing the bracket (i.e. screws).
  - The textured surface should be facing the wall. This surface texture assists the use of adhesives if required.
  - Be sure that the bracket is level and is straight before attaching to the wall.
  - Allow enough space above the bracket so that when attaching the wall control panel, it is not obstructed.
2. Set the rear panel DIP switches before the wall control panel is locked into bracket:
  - Refer to *Wall Control Panel DIP switch settings, page 24*.
3. Connect the RJ45 connector(s), located on the base of the unit, before the wall control panel is attached to bracket:
  - Be sure to plan and consider the bend radius of cables. It strongly recommended that the shortest possible RJ45 connector is used when terminating, this is to maximize bend radius of cables in the confined space.
  - Refer to *Wall Control Panel, page 18*.
4. Place wall control panel onto bracket. Once the 4 lugs have been placed correctly onto the unit, slide the unit down the bracket until it clicks into place.
  - If the unit does not sit correctly into the lugs, be sure that you have not used screw heads that are too big to fit in the channels on the rear of the unit.
5. Removing the wall control panel from the bracket (if required):
  - With the use a flat blade screwdriver press down the bracket locking mechanism, located on the bottom right hand side, and gently slide the unit upwards, this removes the unit from the bracket.

### Notice!



The maximum number of wall control panel IDs that can be configured via DIP switch is 16 (8 BGM controllers and 8 mic./line controllers). Refer to *Wall Control Panel DIP switch settings, page 24* for more information. The maximum safe cable distance from the DSP matrix mixer to the last wall control panel is 500m. This may be extended with the use of better cable and less wall control panels on that cable run. If the cables are exposed; use black or white CAT-5 cables. This makes for a better visual look once installed.

## 5.4 PC GUI software

Configuration of the DSP matrix mixer / system (inputs, outputs, settings and controls) is done by the PLENA matrix graphical user interface (GUI) PC software. Use the Amplifier PC software GUI, when configuring the multi channel DSP amplifier. It is important to always use the most up-to-date version of the PC GUI. Please check [www.boschsecurity.com](http://www.boschsecurity.com) for the latest software updates.

### 5.4.1 PC requirements

The Plena Matrix GUI configuration application software packages can be installed on any PC running the Microsoft Windows XP SP3, Windows Vista, Windows 7 or Windows 8 (non RT) operating system. Make sure that the PC is working correctly and free of viruses before installing the GUI configuration software. Using embedded operating systems is not recommended.



#### Notice!

Be sure that you use a user account with full Windows administration rights before starting software installation.

### 5.4.2 PC GUI application software installation

The following instructions explain how to install the Bosch Plena Matrix GUI application software onto your Windows PC.

1. Download the latest version of PC GUI software from the Bosch website: [www.boschsecurity.com](http://www.boschsecurity.com).
  - Follow the on-screen instructions from the setup wizard.
  - The installation process is started.
2. Click the **finish** button.



#### Notice!

The installation may prompt you to install Microsoft .NET framework 4.0, this is required to be able to run this GUI. Please follow the link provided onscreen to download and install before proceeding.

#### See also

- *Connections, page 18*
- *Configuration, page 23*



---

## 5.5 iOS GUI software

The iOS GUI is designed for use with iPad or iPad mini. This GUI app is designed for the end user who requires more control over the system (than is provided by the wall control panel) to wirelessly control and mix inputs in individual zones via the PLM-8M8 DSP Matrix Mixer. The interface is similar in terms of features to the PC GUI user interface screen. The iOS app is available for download via the app store.



### **Notice!**

To use the iOS GUI app will require the connection and configuration of a wireless router. Please refer to the manual supplied with the wireless router for appropriate configuration.

---

## 6 Connections

- *Call Station, page 18*
- *Wall Control Panel, page 18*
- *Multi channel DSP Amplifier, page 19*
- *DSP Matrix Mixer, page 21*

### 6.1 Call Station

Call stations are (daisy-chained) connected to the DSP matrix mixer with UTP type CAT-5 cable using RJ45 connectors. The connectors are located on the rear side of the call station.

Item	Description
Dual RS485 input/output	Standard RJ45 socket for RS485 data communication, power supply for the unit and single channel audio bus.



#### Notice!

If the cables are exposed; use black or white CAT-5 cables. This makes for a better visual look.

### 6.2 Wall Control Panel

Wall control panels are (daisy-chained) connected to the DSP matrix mixer with UTP type CAT-5 cable using RJ45 connectors. The connectors are located on the rear of the unit.

Item	Description
Dual RS485 input/output	Standard RJ45 socket for RS485 data communication and power supply for the unit.



#### Notice!

Do NOT use a RJ45 cable boot or sleeve when terminating these cables. Using such items may result in the cables not fitting into the device or the bend radius of the UTP to be exceeded.

### 6.3 Multi channel DSP Amplifier

When the multi channel DSP amplifier is connected to the DSP matrix mixer it is recommended to connect via either Amp Link connectors or the phoenix terminal inputs. The amplifier also has XLR/TRS combo inputs in case it will be used without the DSP matrix mixer.

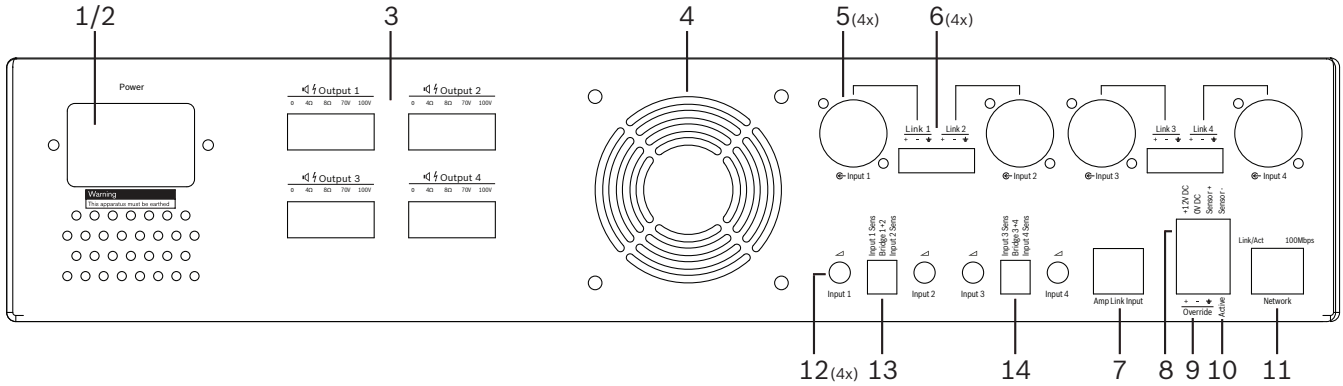

Number	Item	Description
1	Power on/off	AC mains power switch.
2	Mains inlet	AC mains input socket.
3	Loudspeaker outputs	<ul style="list-style-type: none"> <li>4 x loudspeaker outputs via Phoenix terminal:</li> <li>Connections: 100V, 70V, 80Ohm, 40hm and 0V.</li> </ul>
4	Fan grille	Exhaust air vent for amplifier cooling. Do not obstruct!
5	XLR/TRS combo inputs/loop out	<ul style="list-style-type: none"> <li>4 x XLR 3-pin balanced line level audio input (1-4). Mainly used when the amplifier is not connected to the DSP matrix mixer (standalone amplifier):</li> <li>The inputs/outputs are internally, in parallel, connected with the associated Phoenix input connectors, for use as either input or loop-through output.</li> <li>XLR 3-pin number connection: 1 = ground, 2 = + signal, 3 = - signal.</li> </ul>
6	Phoenix inputs/loop out	<ul style="list-style-type: none"> <li>4 x 3-pole Phoenix connector audio input (1-4):</li> <li>The inputs/outputs are internally, in parallel, connected with associated XLR/TRS combo input/loop out connectors for use as either input or output.</li> <li>Left to right pin configuration: 1 = + signal, 2 = - signal, 3 = ground.</li> </ul>
7	Amp Link connection	<ul style="list-style-type: none"> <li>1 x RJ45 connector. Connects 4 sequential channels of the amplifier to the DSP matrix mixer. Processor output channels 1-4 or 5-8.</li> <li>For best practice Bosch recommends use with STP CAT-5 (e) cable.</li> <li>Maximum recommended cable distance 5m.</li> </ul>
8	Auto Standby Mode connections	<ul style="list-style-type: none"> <li>4-pole Phoenix connector to attach a Bosch motion sensor, to activate auto standby.</li> <li>The amplifier also can supply 12V DC power for a motion detector.</li> <li>Left to right pin configuration: 1= +12V DC, 2 = 0V DC, 3= Sensor +, 4 = Sensor -.</li> </ul>
9	Override input	<ul style="list-style-type: none"> <li>4-pin pluggable screw socket/connector with ESD protection:</li> <li>Logic override input (+, - and shield balanced input).</li> </ul>

---

Number	Item	Description
10	Active	<ul style="list-style-type: none"><li>- Contact closure to activate the “Override input”:<ul style="list-style-type: none"><li>- Use the 0 VDC from the sensor above as the common.</li></ul></li></ul>
11	Network	<ul style="list-style-type: none"><li>- RJ45 Ethernet communication socket:<ul style="list-style-type: none"><li>- Communication with the PLENA matrix GUI application.</li></ul></li></ul>

---

**Warning!**

The 12V DC power output (Auto Standby) connection should be only connected with products in accordance with recommendations outlined in this manual.

---

**Notice!**

Recommended motion sensors for use with the auto standby mode are the Bosch range of sensors.

For more information regarding Bosch security products contact your local Bosch Security certified partner or go to [www.boschsecurity.com](http://www.boschsecurity.com) for details.

---

**Notice!**

It is recommended that the cable used Amp Link cable is a high quality STP CAT-5 (e) cable. Amp Link cable distances should not exceed 5 meters per cable.

---

## 6.4 DSP Matrix Mixer

Call stations and wall control panels, are connected to the PLM-8M8 DSP matrix mixer via CAT-5 cable using RJ45 connectors. The multi channel DSP amplifiers are connected to the DSP matrix mixer either via Amp Link or via the output Phoenix connectors. All other connected wiring must be of a professional quality and preferable screened.

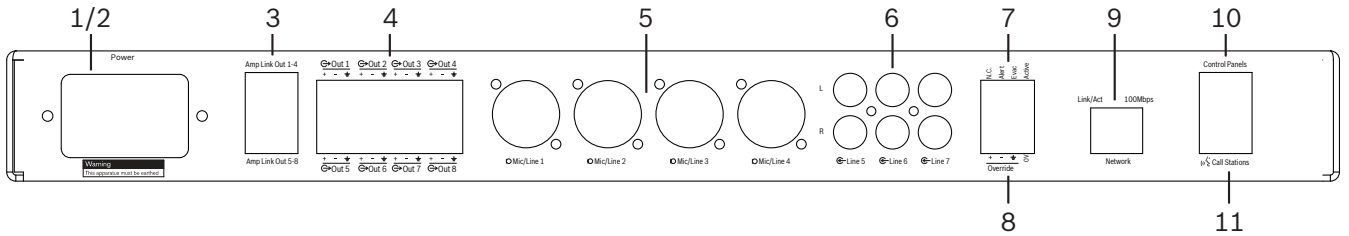

Number	Item	Description
1	Power on/off	AC mains supply switch.
2	Mains inlet	AC mains input socket.
3	Amp Link outputs	<ul style="list-style-type: none"> <li>- RJ45 socket for Amp Link connection:</li> <li>- Amp Link 1-4 output duplicates the outputs of outputs 1-4.</li> <li>- Amp Link 5-8 output duplicates the outputs of outputs 5-8.</li> <li>- The maximum cable length between DSP matrix mixer and the multi channel power amplifier: 5 m / 16.42 ft.</li> <li>- <b>Do not connect any device, other than a PLM-4Px2x amplifier!</b></li> </ul>
4	Phoenix zone outputs	<ul style="list-style-type: none"> <li>- 3-pole Phoenix screw terminal connection per output channel:</li> <li>- Balanced line out.</li> </ul>
5	Mic./Line input	<ul style="list-style-type: none"> <li>- 4 x XLR balanced microphone/line level audio input (1-4):</li> <li>- XLR 3-pin number connection: 1 = ground, 2 = + signal, 3 = - signal.</li> </ul>
6	Line inputs	<ul style="list-style-type: none"> <li>- 3 x 2 RCA summed line input sockets for external music sources.</li> </ul>
7	Active contact	<ul style="list-style-type: none"> <li>- 4-pin pluggable screw socket/connector with ESD protection:</li> <li>- From left to right; Pin 1: Alert, Pin 2: evac, Pin 3: override, Pin 4: ground.</li> <li>- Pin 1, 2 and 3 logic inputs, triggers with ground pin 4.</li> </ul>
8	Override input	<ul style="list-style-type: none"> <li>- 4-pin pluggable screw socket/connector with ESD protection:</li> <li>- Audio line level analog override input (+, - and shield balanced input).</li> </ul>
9	Network	<ul style="list-style-type: none"> <li>- RJ45 Ethernet communication socket:</li> <li>- Communication with the PLENA matrix GUI applications.</li> </ul>
10	Wall control panel	<ul style="list-style-type: none"> <li>- RJ45 socket for RS485 data communication, power and audio bus:</li> <li>- <b>Do not connect any other device, other than wall control panels!</b></li> <li>- <b>Maximum 16</b> daisy-chained wall control panels.</li> <li>- <b>Maximum safe cable distance; 500 m / 1640.42 ft to the final unit.</b></li> </ul>
11	Call station	<ul style="list-style-type: none"> <li>- RJ45 socket for RS485 data communication, power and audio bus:</li> <li>- <b>Do not connect any other device, other than call stations or wall control panels!</b></li> <li>- <b>Maximum 8</b> daisy-chained call stations.</li> <li>- <b>Maximum safe cable distance; 500 m / 1640.42 ft to the final unit.</b></li> </ul>

**Notice!**

Hardware settings cannot be overruled or changed by the PC GUI application software.

---

**See also**

- *DSP Matrix Mixer and Amplifiers, page 13*

# 7 Configuration

- Call Station DIP switch settings, page 23*
- Wall Control Panel DIP switch settings, page 24*
- Multi Channel DSP Amplifier settings, page 25*
- DSP matrix mixer PC GUI, page 26*
- Multi Channel DSP Amplifier PC GUI, page 28*

## 7.1 Call Station

Configuration of zone groups, printable labels for the call stations and chimes is done via the PC software GUI. Refer to *DSP matrix mixer PC GUI, page 26*.

### 7.1.1 Call Station DIP switch settings

DIP switches are used to set individual ID numbers to the call stations. This is so it can be recognized by the DSP matrix mixer in the system. Each connected call station must have its own individual ID assigned.

1. To set the call-station ID use the 3-way DIP switch on the base of the unit:
  - Factory default ID setting: call station 1 (all switches are OFF).

	Call station ID numbers							
DIP switch	1*	2	3	4	5	6	7	8
1	OFF	ON	OFF	ON	OFF	ON	OFF	ON
2	OFF	OFF	ON	ON	OFF	OFF	ON	ON
3	OFF	OFF	OFF	OFF	ON	ON	ON	ON

\* Factory default.



**Notice!**

A DIP switch in the down position is OFF.

A DIP switch in the up position is ON.

Eg. Down – Up - Down will equal call station ID number 3 in the table above.

## 7.2 Wall Control Panel DIP switch settings

The wall control panel is designed to control either the back ground music inputs or the mic./line inputs in one specific zone. As such each wall control panel requires an ID to let the DSP matrix mixer know which unit (or zone) is requesting a change in source or volume. This is done via DIP IDs switches to allocate a number to the unit and its function. The DIP switches are located on the backside of the wall control panel.

- There are two sets of IDs that give the wall control panel different functions:
  1. DIP IDs 1-8 : Line input (background music (BGM)) source selection corresponding to output zones 1-8.
  2. DIP IDs 9-16 : Mic./line input select and mic./line mix mode for output zones 1-8. (e.g. ID 9 = Zone 1, ID 16 = Zone 8).

DIP switch	Wall control panel number ID															
	Line input (BGM) source selection								Mic./line mix mode							
	1*	2	3	4	5	6	7	8	9	10	11	12	13	14	15	16
1	OFF	ON	OFF	ON	OFF	ON	OFF	ON	OFF	ON	OFF	ON	OFF	ON	OFF	ON
2	OFF	OFF	ON	ON	OFF	OFF	ON	ON	OFF	OFF	ON	ON	OFF	OFF	ON	ON
3	OFF	OFF	OFF	OFF	ON	ON	ON	ON	OFF	OFF	OFF	OFF	ON	ON	ON	ON
4	OFF	OFF	OFF	OFF	OFF	OFF	OFF	OFF	ON	ON	ON	ON	ON	ON	ON	ON

\* Factory default.

### Notice!



A DIP switch in the down position is OFF.

A DIP switch in the up position is ON.

Example:

If all DIP Switches are down/OFF this is ID 1 (Factory default).

If all DIP switches are up/ON this is ID 16.



### Notice!

Hardware settings cannot be overruled or changed by the GUI application software.



### 7.3 Multi Channel DSP Amplifier settings

The multi channel DSP amplifier does not require an ID to be connected to the DSP matrix mixer. Amplifier settings that are configured by DIP switches are; input sensitivity and bridging channels together. The DSP features are only able to be configured, after you have connected to the unit using the PC software GUI. Refer to; *Multi Channel DSP Amplifier PC GUI, page 28*).

Some amplifier settings are configured by DIP switches; such as, the input sensitivity and when bridging channels together.

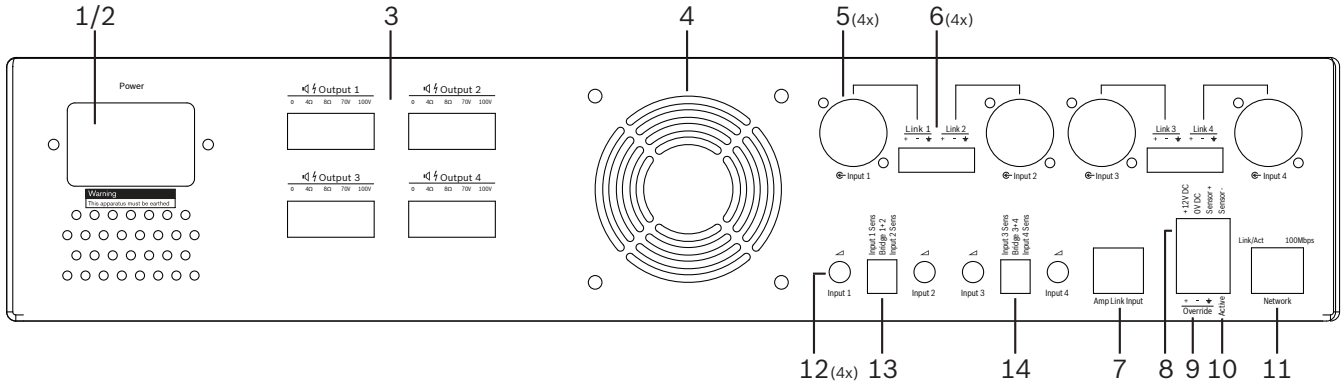

Number	Item	Description
12	Line input control	<ul style="list-style-type: none"> <li>4 x audio input (1-4) level adjustment control:                             <ul style="list-style-type: none"> <li>The range of attenuation is approximately between 0dB and &gt;50dB.</li> </ul> </li> </ul>
13	Input sensitivity / bridge (input 1 and 2 shown)	<ul style="list-style-type: none"> <li>3-way DIP switch for input level sensitivity and bridge mode setting:                             <ul style="list-style-type: none"> <li>Switch 1: Input Sensitivity Channel X: 6.15V (UP) / 1.22V (DOWN) input sensitivity. Default: DOWN.</li> <li>Switch 2: Bridge Channels X-Y: Active (UP), Single channel mode (DOWN). Default: DOWN.</li> <li>Switch 3: Input Sensitivity Channel Y: 6.15V (UP) / 1.22V (DOWN) input sensitivity. Default: DOWN.</li> </ul> </li> </ul>
14	Input sensitivity / bridge (input 3 and 4 shown)	<ul style="list-style-type: none"> <li>3-way DIP switch for input level sensitivity and bridge mode setting:                             <ul style="list-style-type: none"> <li>Switch 1: Input Sensitivity Channel X: 6.15V (UP) / 1.22V (DOWN) input sensitivity. Default: DOWN.</li> <li>Switch 2: Bridge Channels X-Y: Active (UP), Single channel mode (DOWN). Default: DOWN.</li> <li>Switch 3: Input Sensitivity Channel Y: 6.15V (UP) / 1.22V (DOWN) input sensitivity. Default: DOWN.</li> </ul> </li> </ul>



**Notice!**

Hardware settings cannot be overruled or changed by the GUI configuration software.

**See also**

- *DSP matrix mixer PC GUI, page 26*

## 7.4 DSP matrix mixer PC GUI

All audio set up configurations for the DSP matrix mixer are done via the PC software GUI. With the DSP matrix mixer PC GUI: audio input levels; audio output levels and controls could be set via the connected PC.



### Notice!

It is impossible to configure the DSP matrix mixer's advance DSP settings without this PC GUI installed and connected!

Refer to *PC GUI software, page 16* installation to install the PC GUI, if needed.

### Proceed as follows:



### Notice!

Changes and updates to this procedure are available in the software down load file.

1. Complete the installation of the PC GUI software. Refer to *PC GUI application software installation, page 16* for more information.
2. Open the PC GUI software program.
3. The DSP PC GUI configuration program starts and the user screen should appear:
  - An offline configuration for the DSP matrix mixer can be made and saved onto the PC, without connection to the unit. This can be saved and uploaded at a later time, if required.
4. To make a connection to the DSP matrix mixer, make sure that an Ethernet cable is connected to the network port of the DSP matrix mixer.
5. To connect to the unit via PC GUI:
  - In the Tool bar - Click **“Device”** and then click **“Connect”**. The **“Connect to target”** window will open.
 

**Note:** If the **“Connect”** is grayed out. Please enter the administrator password/ hardware password under the **Admin** menu or contact the installer assistance.
  - Click **“Search/Refresh”** to discover the active units connected to the network. Select the unit you wish to control. Click on which way you would like the data to flow during connection; either **“Read configuration from device”** or **“Write configuration to device”** buttons.
 

**Read configuration from device :** This will read or extract the settings from the selected unit and display them on your PC GUI. You can then control the system.

**Write configuration to device:** This will send the configuration that is on the PC GUI to the unit.
  - You are now online. The green **“Online”** Light should be illuminated on the GUI screen.



### Notice!

When selecting “Write configuration to device”. You will clear and wipe all existing setting on the device.

There is no undo button for this after the task has been completed.

6. Changing details of the unit:
  - To change the unit from DHCP to a static IP configuration, follow the procedure above to open the connect to target window. Once in the unit is selected, you can change:

- Turn DHCP on/off.
  - Set a static IP address.
  - Change the device name for easy identification in larger systems.
7. The GUI should now be connected and online in the “**User page**” where inputs can be mixed into different zones.
  8. To access the DSP configuration page go to “**Config**” in the menu bar and select “**DSP setup**”.



**Notice!**

For more information regarding the operation of features within the GUI, please read the GUI operation document.

**DSP matrix mixer PC GUI control functions:**

**User page:**



**Figure 7.1: DSP matrix mixer GUI main screen**

- Mixing and Level control of the 4 Mic./line inputs; per zone.
- Selection of the Line inputs and level control; per zone.
- Master level control; per zone.
- Call station input level control; per zone.
- Soft standby.
- Global mute.
- Connect to device.

**DSP setup page:****Figure 7.2: DSP matrix mixer GUI setup screen**

- Input level control (iPad, +48V, HPF).
- Input DRC – Dynamic Range Compression.
- Input Parametric EQ (Mic./Line 5 bands, Line inputs 3 bands).
- Assign.
- Crossover (8th order).
- Output Zone EQ (7 bands).
- Delay.
- DRC- Dynamic Range Compression.
- Output level Control.
- Output assignment.

**Other DSP matrix mixer configurations in the GUI:**

- Priority set up.
- Ducking levels.
- Password set up.
- Call station set up.

**See also**

- *Troubleshooting, page 41*

**7.5****Multi Channel DSP Amplifier PC GUI**

All DSP features for the multi channel DSP amplifier are controlled via the PC software GUI. With the amplifier PC GUI: fault monitoring can be viewed and DSP features can be configured or controlled via the connected PC.

**Notice!**

Unlike the DSP matrix mixer, the amplifiers can work as a basic amplifier (i.e. without the use of the DSP features). Level controls for each amplifier channel are on the rear of the unit. Refer to *PC GUI software, page 16* installation to install the PC GUI, if needed.

**Proceed as follows:****Notice!**

Changes and updates to this procedure are available in the software download file.

1. Complete the installation of the PC GUI software. Refer to *PC GUI application software installation*, page 16 for more information.
2. Open the PC GUI software program.
3. The amplifier PC GUI program should open and the user screen should appear:
  - An offline configuration of the amplifier can be made without connection to a DSP matrix mixer, and uploaded to the DSP matrix mixer at a later time (optional).
4. To make a connection to the hardware, make sure that an Ethernet cable is connected between the PC and to the network port of the amplifier.
5. To connect to the unit via PC GUI:
  - In the Tool bar - Click “**Device**” and then click “**Connect**”. The “**Connect to target**” window will open.
 

**Note:** If the “**Connect**” is grayed out. Please enter the administrator password/hardware password under the **Admin** menu or contact the installer assistance.
  - Click “**Search/Refresh**” to discover the active units connected to the network. Select the unit you wish to control. Click on which way you would like the data to flow during connection; either “**Read configuration from device**” or “**Write configuration to device**” buttons.
 

**Read configuration from device** : This will read or extract the settings from the selected unit and display them on your PC GUI. You can then control the system.

**Write configuration to device:** This will send the configuration that is on the PC GUI to the unit.

**Note:** This will overwrite all the current settings in the device.
  - You are now online. The green “**Online**” Light should be illuminated on the GUI screen.



#### Notice!

When selecting “Write configuration to device”. You will clear and wipe all existing setting on the device.

There is no undo button for this after the task has been completed.

6. Changing details of the unit:
  - To change the unit from DHCP to a static IP configuration, follow the procedure above to open the connect to target window. Once in the unit is selected, you can change:
    - Turn DHCP on/off.
    - Set a static IP address.
    - Change the device name for easy identification in larger systems.
7. The GUI should now be connected and online in the “**User page**” where inputs can be mixed into different zones.
8. To access the DSP configuration page go to “**Config**” in the menu bar and select “**DSP setup**”.



#### Notice!

For more information regarding the operation of features within the PC GUI, please read the PC GUI operation document in the help menu of the PC GUI.

Refer to *DSP matrix mixer PC GUI*, page 26 when use the amplifier connected to the DSP matrix mixer.

## Functions viewed and/or controlled with the amplifier PC GUI configuration page:

### Main page:



**Figure 7.3: Amplifier GUI main screen**

- Output levels for each amplifier channel.
- Fault monitoring.
- Mute per amplifier channel.
- Connect to device.

### DSP setup page:



**Figure 7.4: Amplifier GUI DSP setup screen**

- Input mixer.
- Crossover.
- Parametric EQ – including Bass Enhancement on/off.
- Delay.
- DRC – Dynamic Range Compression.
- Output Level control.

### See also

- *Troubleshooting, page 41*

### 7.5.1

#### Amplifier Bridging Configuration

1. Set the **Bridge** DIP switch (**13** and **14**) on the rear of the unit to the **ON** position (1+2 or 3+4).
2. Restart the amplifier, as the value of the DIP switches is only read during powering up.
3. Wiring the outputs; The two channels being bridged together should have the commons (0V) connected together, and then either the 4/8/70V/100V taps off the two channels are then used for the + ve and the – ve to the speaker cable.



#### Warning!

Bridging the 70V and 100V lines, the voltage will be 140V and 200V respectively.

---



#### Caution!

Be sure that the higher voltage does not create a problem for the speakers used:  
If any problem exists, this may be solved with the use of a 2:1 step down transformer

---

## 8 Operation

Call stations and wall control panels can only operate when connected to the DSP matrix mixer and individual IDs have been set via the DIP switches on the units. Refer to *Call Station DIP switch settings, page 23* and *Wall Control Panel DIP switch settings, page 24*.

The multi channel DSP amplifier can operate both as a standalone amplifier or connected to the DSP matrix mixer.

### 8.1 Start

1. Check that all connections have been made to relevant units in the system including wall control panels and call stations.
2. Power on the DSP matrix mixer followed by the amplifiers.
3. Check that the power LED are illuminated on the front of the DSP matrix mixer and amplifier(s) (19" rack unit(s)).
4. Check that the RS485 LED is flashing for connections to the wall control panels and call stations.
5. Make sure that the level controls on the rear of the amplifier are set to the desired level.
6. For use with the PC GUI software, Click "**Device**" from the menu bar, and then "**Connect**". Refer to *PC GUI software, page 16*.
  - If the above steps have been followed the system should be in its last mode of operation. However, if this is the initial power-up of the system, it will be obviously be in its factory default state.
  - If all of the above steps have been followed and the system is not working correctly, refer to the *Troubleshooting, page 41* section of this manual.

**Continue with one of the following chapters:**

- *Call Station, page 33*
- *Wall Control Panel, page 35*
- *Multi Channel DSP Amplifier, page 37*
- *DSP Matrix Mixer, page 39*



## 8.2 Call Station

The call station is used to make announcements in pre-selected loudspeaker zones.



**Notice!**

Upon start up, the call stations will need to be identified by the processor. During this period the LEDs will flash in a rotating sequence; once this is complete the system is ready. Allow approx. 15 seconds before attempting an announcement.

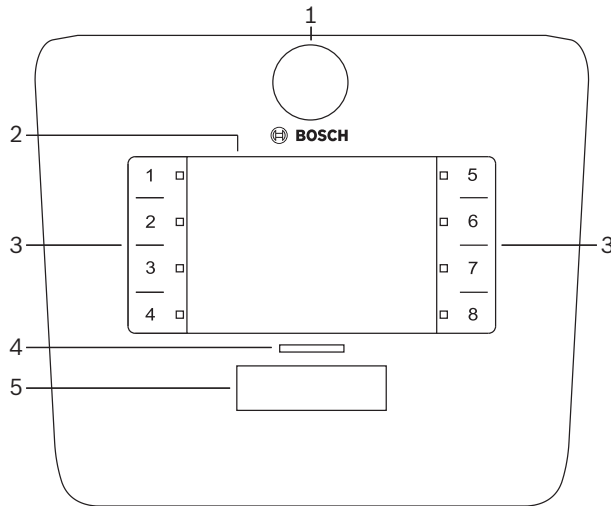

Number	Item	Description
1	Microphone	Flexible gooseneck microphone stem with paging call activity LEDs (green).
2	Zone label	Paper labels can be inserted behind the thin plastic cover. Paper labels can be typed and printed out via the PC GUI software.
3	Zone selection button	This section allows the user to select the zone(s) that have been previously configured in the PC GUI Software.
3	Zone selection LED	1-8 selection LED indicator (green/on = zone selected). On start up LEDs flash in a sequence.
4	PTT LED	<ul style="list-style-type: none"> <li>- Bi-color LEDs above the PTT button indicating:                             <ul style="list-style-type: none"> <li>- <b>Red:</b> Busy. Another call-station is currently making a call/announcement. This call-station cannot be used to make a paging call, until the current call/announcement is finished.</li> <li>- <b>Yellow:</b> Wait. Your paging call is attempting to start. Do not speak yet.</li> <li>- <b>Green:</b> Ready. The call station microphone is active, you may talk.</li> </ul> </li> </ul>
5	PTT button	- Press-to-talk (paging call) button. Keep button pushed down to continue to talk.

**Continue with:**

- *Pre-settings and selections, page 34*
- *Making an announcement, page 34*

### 8.2.1 Pre-settings and selections

The following pre-selections and settings have to be done by the DSP matrix mixer PC GUI application at configuration of the system. Refer to *DSP matrix mixer PC GUI, page 26*

- Setting button functions - zone groups per call station (see PC GUI help file for more information).
- Chime generation (enable/disable).
- Microphone gain control.
- The call-station ID setting is pre-defined at configuration. Refer to *Call Station DIP switch settings, page 23*.

### 8.2.2 Making an announcement

1. Select zone(s) by touching the numbered capacitive zone selection areas:
  - The zone selection LED indicates the zone group to which the announcement is distributed.
  - To deselect the zone group, touch the capacitive area again (LED is off).
2. Multiple zone groups can be selected by continuing to use the numbered capacitive touch areas. Push the press-to-talk (PTT) button:
  - When the LED above the PPT button goes green, you are ready to talk. Refer to *Call Station, page 33*.
  - Only one call-station in the system is able to make an announcement at one time.

#### Notice!



Use slow deliberate touches on the capacitive touch areas on products. Excessively fast tapping may not be recognized by the unit.

A good rule when making an announcement through the call station is to keep at least one hands distance away from the microphone. This will reduce popping noises and distortion in the system.

### 8.3 Wall Control Panel

The wall control panel is used to select the input source and to adjust the audio volume level in the pre-selected loudspeaker zones.

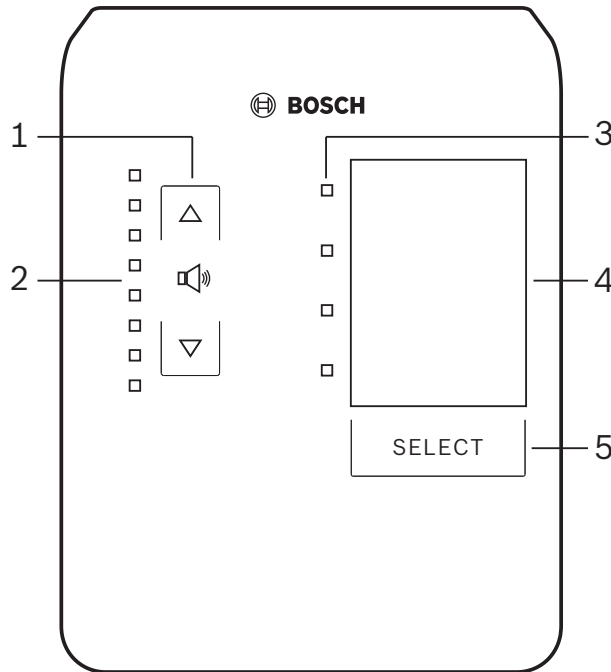

Number	Item	Description
1	Volume level up/down button	2 x capacitive button to control the zone audio volume level up or down.
2	Volume control LED	<ul style="list-style-type: none"> <li>- 8 x LED indicating the selected audio source's volume level:                             <ul style="list-style-type: none"> <li>- Top LED: 0dB attenuation.</li> <li>- -6dB attenuation.</li> <li>- -12dB attenuation.</li> <li>- -18dB attenuation.</li> <li>- -24dB attenuation.</li> <li>- -30dB attenuation.</li> <li>- -36dB attenuation.</li> <li>- Bottom LED: &lt;= -40dB attenuation.</li> </ul> </li> <li>- LEDs off: Mute.</li> </ul>
3	Input source selection LED	4 x LED indicating; Line input sources (1, 2, 3 or off) or mic./line (1, 2, 3 or 4).
4	Input source label	A paper label to identify input sources can be inserted behind the thin plastic cover. Paper labels can be typed and printed out via the PC GUI software.
5	Input source selection button	Capacitive button to toggle through the connected line input sources (1, 2, 3 or off) or mic./line (1, 2, 3 or 4) input source.

**Continue with:**

- *Select the input source, page 36*
- *Adjust the audio output volume level, page 36*

### 8.3.1

#### Select the input source

1. Select the input source with the capacitive touch button labelled “**Select**”:
  - The input source selection LED indicates the input source or off.
  - **NOTICE:** The source (microphone inputs or line inputs), ID and zone selection are pre-defined at configuration. Refer to *Wall Control Panel DIP switch settings, page 24*.

### 8.3.2

#### Adjust the audio output volume level

1. Press the capacitive touch buttons up or down arrows to adjust audio level:
  - One touch per 3 dB step.
2. The volume control LED indicates the audio output volume level:
  - The maximum level indicated is dependent upon the predefined maximum allowable level that is set in the PC GUI (DSP setup output level).



#### Notice!

Use slow deliberate touches to the capacitive touch areas on products. Excessively fast tapping may not be recognized by the unit.



#### Notice!

The level will increase or decrease 3dB for every button press of the arrows, and the LED is 6dB per step. Therefore it will sometimes require 2 pushes to see the next LED illuminate.

## 8.4 Multi Channel DSP Amplifier

The multi channel amplifier’s DSP is able to be used to process audio signals for up to 4 zones. The amplifiers can be used either with or without the DSP functionality.

The amplifier can be used standalone or connected to the DSP matrix mixer.

Refer to *DSP Matrix Mixer*, page 21 if the amplifier is only connected to the DSP matrix mixer and loudspeaker output zones.

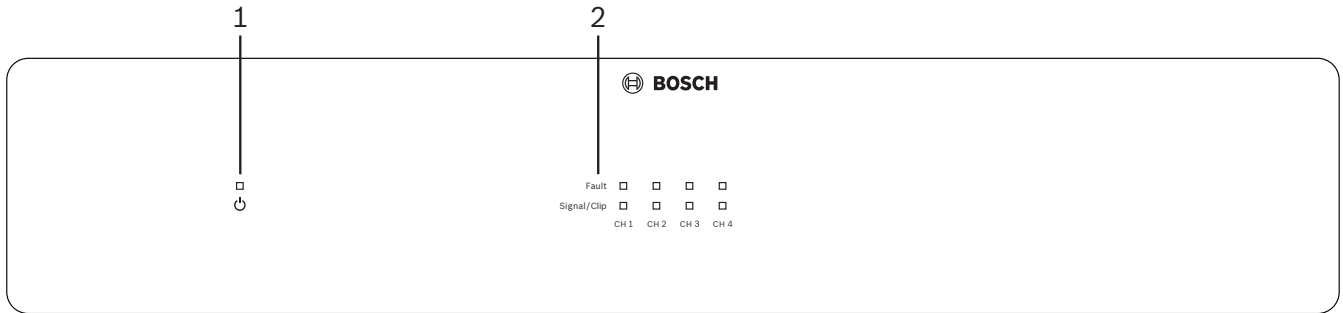

Number	Item	Description
1	Power on LED	Flashes (green) during power up. It becomes solid (green) as soon the amplifier is ready-for-use.
2	Input signal LEDs	<ul style="list-style-type: none"> <li>- Two LEDs per amplifier input channel (4x) indicating:                             <ul style="list-style-type: none"> <li>- Protect/fault. On (red), indicates an amplifier fault. Refer to <i>Troubleshooting</i>, page 41 section.</li> <li>- Signal presence/clip bi-color LED: On, when the applied audio input signal is -40dB from clip (green), -3dB from clip (amber), 0dB full output power (red).</li> </ul> </li> </ul>

### Standalone without connection to the PC GUI

After following the guide on setting up the input sensitivity and bridging (if required).

1. Turn on the amplifier.
2. Use level controls on the rear of the unit to set desired output level (The factory preset configuration is input 1 is routed to output 1 etc. All internal levels are set to unity gain).
3. If usage with the auto standby mode is required, the preset time out is 1 hour.

### With DSP / PC GUI functionality

After following the guide on setting the input sensitivity and bridging (if required).

1. Turn on the amplifier.
2. Use level controls on the rear of the unit, to set desired output level:
  - Usually these level controls are set to full, as you can adjust the levels down within the PC GUI.
3. Open the PC GUI program and click on "**Device**" in the menu bar, and then click "**Connect**":
  - Refer to *Multi Channel DSP Amplifier PC GUI*, page 28 for configuration details.
4. If required, more information on using the PC GUI can be found in the help menu.
  - Refer to *Multi Channel DSP Amplifier PC GUI*, page 28; for DSP features.



### Notice!

Hardware settings (controls and switches) cannot be overruled or changed by the DSP matrix mixer and amplifier PC GUI configuration software.

The following operations can be done when using the amplifier hardware in either mode or operation:

- Activate the active override audio input function, page 38.
- Activate the amplifier auto standby, page 38.

### 8.4.1

#### Activate the active override audio input function

The active audio override function is used when you want to temporarily override all existing configurations on all amplifier outputs, with a signal supplied by the override audio input.

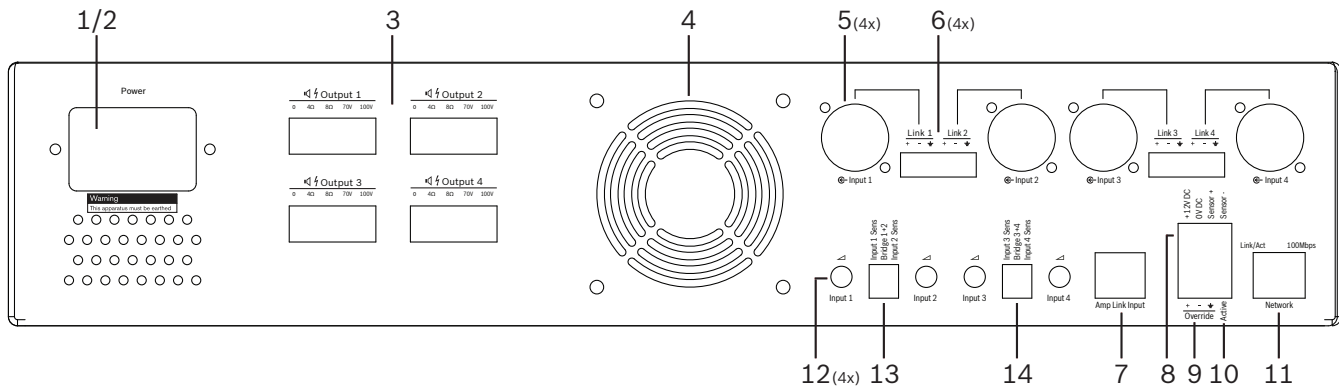

1. Trigger the active audio override contact closure on the amplifier rear panel (**10**) via the phoenix connection labelled “**Active**”:
  - The override input signal now has a higher priority than all the other input sources, and is active immediately into all channels.
2. By opening the contact again, the override input signal stops:
  - The unit will restore and return to its prior configuration immediately.

### 8.4.2

#### Activate the amplifier auto standby

The amplifier auto standby function is used when you want to switch the amplifier to standby mode. Standby mode activates to save power, which reduces running costs and extends the lifetime of the amplifier. You can set the length of time that there is no activity in a zone using the amplifier DSP. The timeout can be as fast as 1 minute or as long as 4 hours (Factory preset is 60 min.).

1. Once a movement sensor has been correctly connected and powered (**8**); any activity that is detected by sensor, resets the standby timeout period.
2. When the timeout has been reached, the amplifier will switch into a highly efficient power saving mode.
  - During standby, if activity is detected via the sensor, or an Active/Alert/EVAC contact closure is engaged; the amplifier “wakes up” and restore and return to its prior configuration immediately.



#### Notice!

The recommended sensor to be used, and can be powered by the amplifier, is the Bosch PIR range of detectors. Refer to [www.boschsecurity.com](http://www.boschsecurity.com).

### 8.4.3

#### Operate the amplifier with the PC GUI

Operating and configuration of the DSP features can only be used via the amplifier PC GUI. Refer to *Multi Channel DSP Amplifier PC GUI*, page 28. Operation instructions are available within help of the PC GUI.

## 8.5 DSP Matrix Mixer

The DSP matrix mixer; the brains of the PLENA matrix system. It has no external controls on the unit itself. To control this unit it requires either connection to the call station and /or wall control panel, or a online connection to the PC GUI.



**Notice!**

It is impossible to control zone volume levels without one of the following; wall control panel, PC or iOS GUI. Refer to *PC GUI software, page 16* to install the PC GUI, if needed.

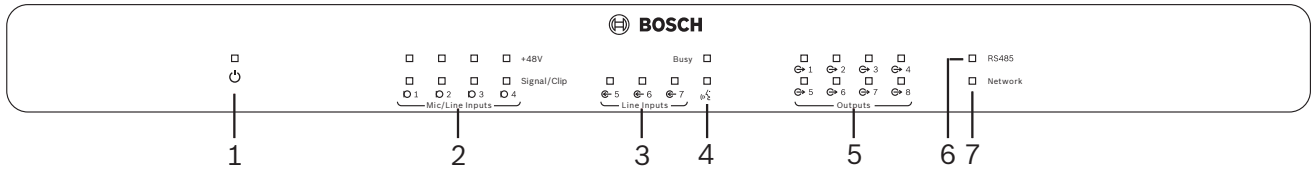

Refer to the following table to check the indicators of the functionality in use.

Number	Item	Description
1	Power on LED	Flashes (green) during power on and initialization. It becomes solid (green) as soon the unit/system is ready-for-use.
2	Mic./Line 1-4 level LED	<ul style="list-style-type: none"> <li>2 x bi-color LED per microphone/line input (4x) indicating:                             <ul style="list-style-type: none"> <li>Microphone +48 V phantom power supply LED: On (yellow), when phantom power supply is supplied to the connected microphone.</li> <li>Signal presence/Clip LED: On, when applied signal is -40dB from clip (green), -3dB from clip (amber), 0dB (red = clip).</li> </ul> </li> </ul>
3	Line input LED	<ul style="list-style-type: none"> <li>Bi-color LED per background music source input (3x) indicating:                             <ul style="list-style-type: none"> <li>Signal presence/Clip LED: On, when applied signal is -40dB from clip (green), -3dB from clip (amber) or 0dB (red = clip).</li> </ul> </li> </ul>
4	Call station LED + signal presence / clip LED	<ul style="list-style-type: none"> <li>2 x bi-color LED on the call-station input indicating:                             <ul style="list-style-type: none"> <li>Announcement active LED. On (yellow), when a call station is making an announcement.</li> <li>Signal presence/Clip LED: On, when applied signal is -40dB from clip (green), -3dB from clip (amber) or 0dB (red = clip).</li> </ul> </li> </ul>
5	Output 1-8 LED	<ul style="list-style-type: none"> <li>Bi-color LED per zone output (8x) indicating:                             <ul style="list-style-type: none"> <li>Signal presence/Clip LED: On, when applied signal is -40dB from clip (green), -3dB from clip (amber) or 0dB (red = clip).</li> </ul> </li> </ul>
6	RS485 LED	Indicates RS485 bus communication (call stations, wall control panels).
7	Network LED	Indicates network/PC communication (e.g. communication with the PC GUI).

### 8.5.1 Activate the override input function

The active override function is used when you want to temporarily override all existing configurations on all outputs, with a signal supplied by the override audio input.

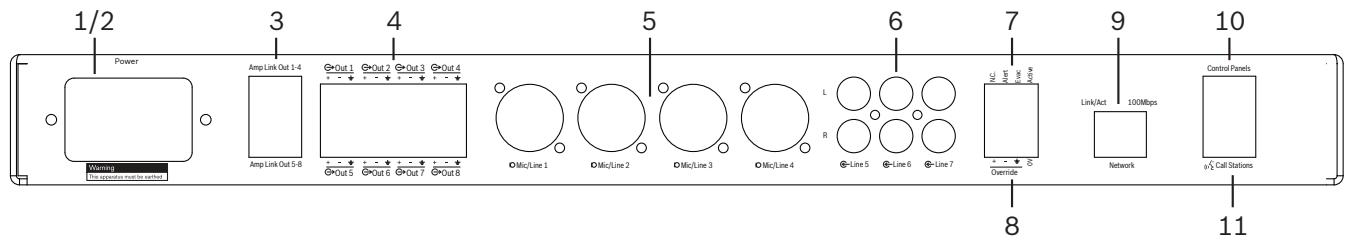

1. Trigger the active audio override contact closure on the units rear panel (**7**) via the phoenix connection labeled **“Active”**:
  - The override input signal (**8**) now has a higher priority than all the other input sources, and is active immediately into all channels.
  - By opening the contact again, the override input signal stops. The unit will restore and return to its prior configuration immediately.
2. Activate the **“Force into override”** via the PC GUI:
  - The override input signal overrules all active audio signals.

### 8.5.2 Activate the Alert/EVAC override function

These override functions are used when you want to override all existing configurations in all zones, with an internally generated alarm signal.

1. Activate the audio override via contact closures the units' rear panel (**7**) using an external device:
  - The override input signal overrules all active audio signals.
  - By opening the contact again, the override tone stops. The unit will restore and return to its prior configuration immediately.
2. Activate the **“Force into Alert Tone”** or **“Force into EVAC Tone”** via the PC GUI:
  - The override input signal overrules all active audio signals.

### 8.5.3 Operating the DSP Matrix Mixer/system with the GUI

Operating and configuration of the DSP features can only be used via the DSP matrix mixer PC GUI. Refer to *DSP matrix mixer PC GUI*, page 26. Operation instructions are available within the help of the PC GUI.



## 9 Troubleshooting

Problem	Possible cause	Possible solution
<b>DSP matrix mixer or amplifier:</b> does not work and power LEDs are not illuminated.	<ul style="list-style-type: none"> <li>– Power (plug) disconnected and/or the unit is switched off</li> </ul>	<ul style="list-style-type: none"> <li>– Insert power cord and switch on the unit.</li> </ul>
<b>DSP matrix mixer or amplifier:</b> No audio.	<ul style="list-style-type: none"> <li>– An audio output cable has come loose or has not been properly plugged in.</li> <li>– Within the PC GUI controls the input or output levels have been muted or reduced to a very low level.</li> <li>– Input source is not working correctly.</li> </ul>	<ul style="list-style-type: none"> <li>– Check all input and output audio connections, Plug in audio cables properly.</li> <li>– Check the audio levels in the PC GUI are not muted or set to a level that is too low.</li> <li>– Check the input source is working correctly and sending an appropriate level of signal.</li> </ul>
<b>DSP matrix mixer or amplifier:</b> The audio output sound is distorted or sounds strange..	<ul style="list-style-type: none"> <li>– The audio output cable has not been properly plugged in.</li> <li>– The correct cables have not been used.</li> <li>– The input level is clipping.</li> <li>– Music source material is not correct.</li> </ul>	<ul style="list-style-type: none"> <li>– Check all connections have been made and plugged in properly.</li> <li>– Check the recommended cables have been used.</li> <li>– Turn down the input level in the PC GUI configuration screen.</li> <li>– Switch music source.</li> </ul>
<b>Amplifier:</b> Fault light constantly ON ( Red).	<ul style="list-style-type: none"> <li>– Indicates a fault with that amplifier channel.</li> </ul>	<ul style="list-style-type: none"> <li>– Send immediately for service and/or contact the Bosch authorized dealer or installer for assistance.</li> </ul>

Problem	Possible cause	Possible solution
<b>Amplifier:</b> Fault light lit for approx. one second.	<ul style="list-style-type: none"> <li>- This is indicating protection on that channel (overload or short condition).</li> </ul>	<ul style="list-style-type: none"> <li>- The amplifier automatically retries the channel after this time (1 min).</li> <li>- Note that the amplifier will not detect a short-circuit directly without signal - for instance, if a short is on the output, but no signal is being driven, the amplifier may not actually be in fault mode. As soon as enough signal is present to activate the current protection the fault LED will light.</li> </ul>
<b>Amplifier:</b> Fault LED flashes quickly for around 30 seconds.	<ul style="list-style-type: none"> <li>- This indicates a thermal error on the channel.</li> </ul>	<ul style="list-style-type: none"> <li>- The channel will be re-activated after it has cooled down.</li> </ul>
<b>Amplifier:</b> Fault LEDs flash slowly.	<ul style="list-style-type: none"> <li>- This indicates that the PSU has failed (or thermally cut-out).</li> </ul>	<ul style="list-style-type: none"> <li>- Send immediately for service and/or contact the Bosch authorized dealer or installer for assistance.</li> </ul>
<b>Call stations / Wall Control Panel's</b> LED keep rotating.	<ul style="list-style-type: none"> <li>- RS485 ID cannot be identified.</li> </ul>	<ul style="list-style-type: none"> <li>- Check that the switches have been full switched to the appropriate positions, and reset power to the unit.</li> <li>- Check that the CAT-5 cable is not damaged in anyway.</li> <li>- Download and connect with the latest version of PC GUI and check the RS485 status "Device &gt; RS486 device status".</li> </ul>

Problem	Possible cause	Possible solution
<b>Wall Control Panel</b> volume control takes two button presses to increase the LED indicator.	<ul style="list-style-type: none"> <li>- The LEDs only indicate +/-6dB steps. The up down arrows increase/decrease the volume in 3dB steps.</li> </ul>	<ul style="list-style-type: none"> <li>- Be assured the unit is not faulty or broken. The unit will be affecting the audio at 3dB every time you press the button. You should listen to audio through the PA system to confirm that this is the case.</li> </ul>
<b>Call station's</b> microphone becomes active without the user touching the PTT button.	<ul style="list-style-type: none"> <li>- Multiple call stations have been set with the same ID.</li> </ul>	<ul style="list-style-type: none"> <li>- Change call stations to have different IDs.</li> </ul>
<b>Call stations / Wall Control Panels</b> do not work. Lights continue to flash around.	<ul style="list-style-type: none"> <li>- The DSP matrix mixer is not able to configure the unit.</li> </ul>	<ul style="list-style-type: none"> <li>- Check that all cables in the cable run are using the correct CAT-5 pin configuration (no crossover cables).</li> <li>- Check if a cable has been damaged in the daisy-chain.</li> </ul>
The <b>call station</b> is activated but, announcement did not come through the system.	<ul style="list-style-type: none"> <li>- Unit has just been turned on.</li> <li>- A chime has been programmed to play before any announcement.</li> <li>- The announcement level is not at a sufficient level for the selected zone.</li> <li>- The user is not speaking loudly enough towards the microphone.</li> </ul>	<ul style="list-style-type: none"> <li>- Wait 15 seconds, until unit has been identified by the DSP matrix mixer before attempting to use it.</li> <li>- Wait for LEDs to turn green on the call station before talking or deactivate the chime via the GUI.</li> <li>- Within the GUI check that all call station levels are set to appropriately and the mute is not activated.</li> <li>- Speak slowly and clearly towards the microphone.</li> </ul>
<b>Rack units</b> are not found in target search.	<ul style="list-style-type: none"> <li>- Ethernet cables have been disconnected.</li> <li>- Unit(s) and/or router are not on.</li> <li>- PC is not connected to network.</li> </ul>	<ul style="list-style-type: none"> <li>- Check all unit are connected to power, check cabling is correctly connected, check that the PC is connected to the network.</li> </ul>

## 9.1 Customer service

If a fault cannot be resolved, please contact your supplier or system integrator, or go directly to your Bosch representative.

## 10 Maintenance

The PLENA matrix system has been designed to operate without problems for a long period of time, with a minimum of maintenance.

In order to guarantee trouble-free operation:

- *Clean the units, page 45*
- *Clean air vents, page 45*
- *Check the connectors and grounding, page 45*



### Warning!

Dangerous mains voltages are present inside the 19" units. Disconnect the mains power supply before you do any maintenance.

### 10.1 Clean the units

Periodically clean all units with a damp, lint-free cloth; never use water or chemicals.

### 10.2 Clean air vents

The multi channel DSP amplifier can collect dust as a result of the internal fan. Base the interval on the actual situation and dust build-up. Start with an interval of at least once a year. Use a vacuum cleaner to clean the air vents of all units.

### 10.3 Check the connectors and grounding

Periodically check:

- All cable connections for corrosion and the screw terminals to make sure that they have not become loosened.
- The ground (PE) connection of the system components.

# 11 Technical Data

## 11.1 Electrical

### 11.1.1 DSP Matrix Mixer

<b>Power supply</b>	
Mains voltage:	
– Nominal input voltage	100 - 240 VAC $\pm$ 10%, 50/60 Hz
– Input voltage limits	90 - 264 VAC
Power consumption:	
– No devices connected	<10 W
– Max. load/max. devices connected	54 W

<b>Performance</b>	
Frequency response (-1dB)	20 Hz to 20 kHz (+0/-3 dB)

<b>Mic./line input</b>	<b>4x</b>
Input Clip level:	
– Pad off	8.4 dBu (6.2 dBV)
– Pad on	24.2 dBu (21.9 dBV)
CMRR (1 kHz, 0 dBFS))	>46 dB
Phantom power supply	48 V
THD	<0.01 %
Dynamic range (A-weighted)	>103 dB
Connectors	4x XLR/TRS combo

<b>BGM inputs</b>	<b>3x</b>
Input clip (Pad on)	10.2 dBu (8 dBV)
THD	<0.004 %
Dynamic range (A-weighted)	>103 dB
Connectors	3x pair of Cinch RCA

<b>Outputs</b>	
Output level	17.7 dBu (15.5 dBV)

<b>Logic inputs</b>	
Connector	2-pole Phoenix terminal (metric)

<b>8CS and WCP (RS485)</b>	
Call station connector	1x RJ45
Wall control panel connector	1x RJ45

<b>Amplifier</b>	<b>2x</b>
Connector	RJ45
Nominal level	1 V
Impedance	<100 ohm

<b>Ethernet (10/100 Mbit/s)</b>	<b>1x</b>
Connector	RJ45

**Notice!**

Maximum load means maximum two multi-channel amplifiers, call stations and wall control panels connected.

**11.1.2****Multi Channel DSP Amplifier**

<b>Power supply</b>	
Mains voltage:	
– Nominal input voltage	100 - 240 VAC ±10%, 50/60 Hz
– Input voltage limits	90 - 264 VAC
Power consumption (-6dB/idle/standby):	
– PLM-4P125	254 W / 27 W / 6 W
– PLM-4P220	412 W / 36 W / 6 W

<b>Performance</b>	
Rated outputs voltage/impedance	100 V / 70 V / 8 ohm / 4 ohm
Rated output power per channel (continuous *):	
– PLM-4P125	130 W
– PLM-4P220	220 W
Rated output power per channel (burst *):	

– PLM-4P125	130 W
– PLM-4P220	220 W
Bridged (CH 1-2 / 3-4) (continuous *):	
– PLM-4P125	250 W
– PLM-4P220	385 W
Bridged (CH 1-2 / 3-4) (burst *):	
– PLM-4P125	250 W
– PLM-4P220	445 W
THD+N (1 kHz, 6 dBFS):	
– PLM-4P125	0.1 %
– PLM-4P220	0.03 %
Dynamic range (A-weighted):	
– PLM-4P125	>101 dB
– PLM-4P220	>102 dB
Frequency response (-1dB)	
	65 Hz to 20 kHz (+0/-3 dB)
Crosstalk @ 1 kHz	
	<-70 dB

\* According to CEA-490-A R-2008

<b>Connectors</b>	
Inputs (wired in parallel):	<ul style="list-style-type: none"> <li>– 4x 3-pin XLR balanced</li> <li>– 4x 3-pole balanced Phoenix terminal (Metric)</li> <li>– 1x RJ45 (Amp Link)</li> </ul>
– Loudspeaker output	4x 3-pole Phoenix terminal (Metric)
– Logic and standby override	2-pole Phoenix terminal (Metric)
Ethernet Network 10/100 Mbps	RJ45
12 V output power for motion sensor	2-pole Phoenix terminal (Metric)



**11.1.3****Call Station**

<b>Power supply</b> (supplied by PLM-8M8)	
Voltage range	30 - 50 VDC
Power consumption	1.5 W

<b>Performance</b>	
Microphone type	Cardoid
Frequency response (-3dB)	100 Hz to 20 kHz (+0/-3 dB)
Input Clip level	-11 dBu (-13.3 dBV)
THD+N (1 kHz, 6 dBFS):	<0.03 %
– Dynamic range (A-weighted) (mid gain setting)	>97 dB(A)
– Output level	24.4 dBu (22.2 dBV)

<b>Connectors</b>	<b>2x</b>
RS485 loop-through	RJ45

**11.1.4****Wall Control Panel**

<b>Power supply</b> (supplied by PLM-8M8)	
Voltage range	30 - 50 VDC
Power consumption	0.5 W

<b>Connectors</b>	<b>2x</b>
RS485 loop-through	RJ45

## 11.2 Mechanical

### 11.2.1 DSP Matrix Mixer

Dimensions (H x W x D)	45 x 440 x 358 mm 1.8 x 17.3 x 14.1 in (19" wide, 1RU high)
Mounting	Stand-alone, 19" rack
Color	Trafic black (RAL 9017) Silver (RAL 9006)
Weight	Approx. 6 kg Approx. 13.23 lb

### 11.2.2 Multi Channel DSP Amplifier

Dimensions (H x W x D)	90 x 440 x 417 mm 3.5 x 17.3 x 16.4 in (19" wide, 2RU high)
Mounting	Stand-alone, 19" rack
Color	Trafic black (RAL 9017) Silver (RAL 9006)
Weight:	
– PLM-4P125	Approx. 15 kg Approx. 33 lb
– PLM-4P220	Approx. 18 kg Approx. 39.7 lb

### 11.2.3 Call Station

Base dimensions (H x W x D)	50 x 156 x 140 mm (2 x 6.1 x 25.5 in)
Microphone stem length	390 mm (15.35 in)
Color	Trafic black (RAL 9017) Silver (RAL 9006)
Weight	Approx. 0.77 kg Approx. 1.69 lb

**11.2.4****Wall Control Panel**

Base dimensions (H x W x D)	130 x 100 x 30 mm 5.1 x 3.9 x 1.2 in
Mounting	Surface mount bracket
Color	Traffic black (RAL 9017) Silver (RAL 9006)
Weight	Approx. 0.13 kg Approx. 0.29 lb

## 11.3 Environmental conditions

### 11.3.1 DSP Matrix Mixer

Operating temperature	-10 °C to +45 °C
Storage temperature	-40 °C to +70 °C
Relative humidity	<95%

### 11.3.2 Multi Channel DSP Amplifier

Operating temperature	-10 °C to +45 °C
Storage temperature	-40 °C to +70 °C
Relative humidity	<95%

### 11.3.3 Call Station

Operating temperature	-10 °C to +45 °C
Storage temperature	-40 °C to +70 °C
Relative humidity	<95%

### 11.3.4 Wall Control Panel

Operating temperature	-10 °C to +45 °C
Storage temperature	-40 °C to +70 °C
Relative humidity	<95%

## 11.4 Standards

EMC emission	According to EN55103-1
EMC immunity	According to EN55103-2



**Bosch Security Systems B.V.**

Torenallee 49

5617 BA Eindhoven

The Netherlands

**[www.boschsecurity.com](http://www.boschsecurity.com)**

© Bosch Security Systems B.V., 2013