

FMC-210-DM Double Action Call Points

www.boschsecurity.com



BOSCH
Invented for life



- ▶ Adjustment of the Manual Call Point after alarm triggering
- ▶ Automatic or manual detector addressing via rotary switch possible
- ▶ Indicator LED for alarm or for inspection evaluation
- ▶ Call point query routines with evaluation and multiple transmission
- ▶ Individual call point identification

The FMC-210-DM Manual Call Points are used for manual triggering, and are deployed in the Local SecurityNetwork LSN and LSN improved. Form H Manual Call Points are designed for outdoor deployment, form G Manual Call Points are designed for indoor deployment.

Functions

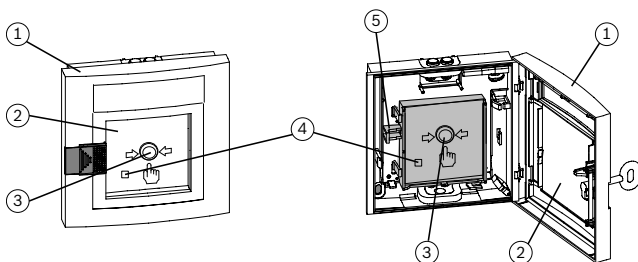

In the event of an alarm, the glass pane (2) is broken first, then the manual call point (3) is pressed hard. This activates the microswitch for alarm triggering and the indicator LED (4) blinks. A mechanism holds the pressed call point down.

The manual call point can be reset with the reset lever (5) or by closing the door of the manual call point (1). The indicator LED (4) goes out.

This does not reset the alarm on the fire panel. Individual call point identification with display of the call point address on the fire panel ensures the quick location of the triggered call point.

Variants

The designs of the manual call points for outdoor and indoor use are identical. The manual call points for indoor use (form G) are available in red, blue, and yellow; the manual call points for outdoor use (form H) are available in red and blue.

Form H manual call points are equipped with an especially resistant PC board layered with parylene.

Improved LSN features

The manual call points offer all the features of the improved LSN technology:

- Flexible network structures, including "T-tapping" without additional elements
- Up to 254 LSN improved elements per loop or stub line
- Automatic or manual detector addressing selectable via rotary switch, in each case with or without auto-detection
- Shielded and unshielded cables can be used
- Cable length up to 3000 m (with LSN 1500 A module)
- Downwards compatibility to existing LSN systems and control panels.

Certifications and approvals

Type Number	Complies with
FMC-210-DM-G-R	EN 54-11:2001/A1:2005, EN 54-17:2005
FMC-210-DM-H-R	EN 54-11:2001/A1:2005, EN 54-17:2005
FMC-210-DM-G-Y	EN 12094-3:2003, EN 54-17:2005
FMC-210-EST-G-B	EN 12094-3:2003, EN 54-17:2005

Region	Certification
Europe	CE FMC-210-DM-G-B/-H-B/-SM-G-B
	CE FMC-210_DM-G-R/-H-R/-SM-G-R
	CE FMC-210-DM-G-Y /EST-G-B
Germany	VdS G 206100 FMC-210_EST-G-B_G206100
	VdS G 206098 FMC-210_DM-G-R/-H-R_G206098
	VdS G 206099 FMC-210_DM-G-Y_G206099
Slovakia	EVPU SK08-ZSV-0071 FMC-210-DM, FMC-210-EST
Czech Republic	TZUS 080_12987 FMC-210
Poland	CNBOP 1505/2013 FMC-210 DM-G-R, FMC-210 DM-H-R
Europe	CPD 0786-CPD-20293 FMC-210-DM-G/H-R
	CPD 0786-CPD-20244 FMC-210-DM-G-Y
	CPD 0786-CPD-20245 FMC-210-EST-G-B
Ukraine	MOE UA1.016-0070338-11 FMC-210-DM-G-R_FMC-210-DM-H-R_FMC-210-DM-G-R-A

Installation/configuration notes

- Manual call points must be mounted visibly along escape and rescue routes (e.g. exits, passageways, stairwells) and be easily accessible.
- An installation height of 1400 mm ±200 mm, measured from the middle of the manual call point to the floor, must be maintained.
- Manual call points must be adequately illuminated by sunlight or another light source (including emergency lighting if present).
- The maximum number of LSN elements that may be connected depends on their current consumption from the LSN data line. The limit values should be taken from the product information supplied with the fire panel used.
- Additional norms, guidelines, and planning recommendations with respect to installation location, etc. must be taken into account (see fire detector manual).
- The regulations of the local fire services must be observed.

Installation

- The cable duct can be surface-mounted or flush-mounted.

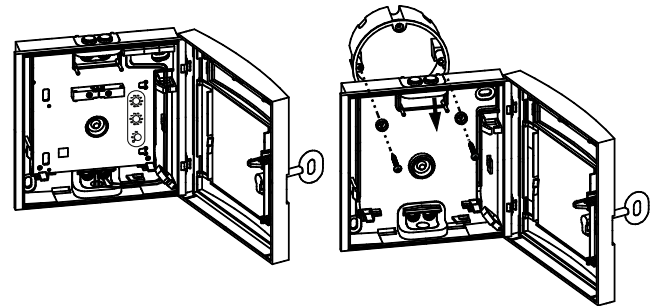

- Installation in fire hose cabinets is possible in three ways:

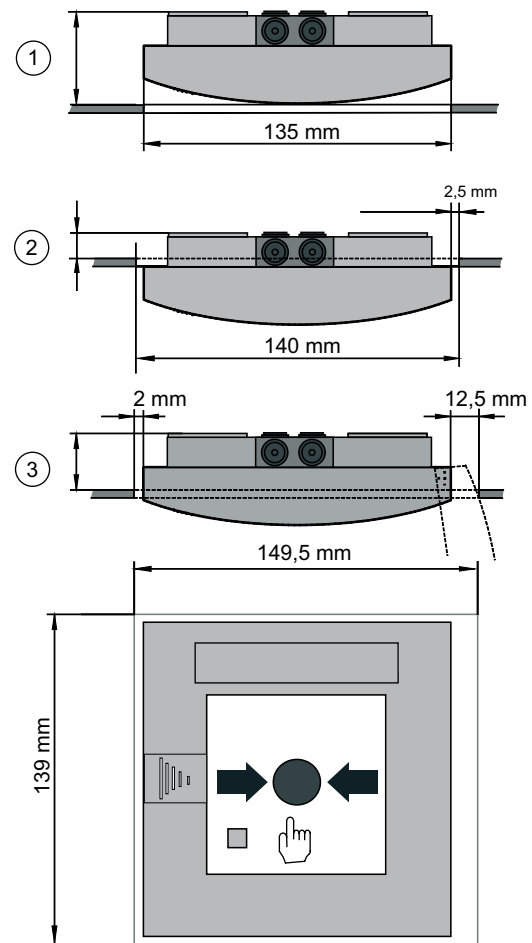

Pos.	Description
1	Installation depth version 1: ca. 40 mm
2	Installation depth version 2: 14 mm
3	Installation depth version 3: min. 30 mm

Parts included

Type Number	Component
FMC-210-DM-G-R Form G, Red	Manual Call Point for indoor use, indirect triggering (type B), housing color red
FMC-210-DM-H-R Form H, Red	Manual Call Point for outdoor use, indirect triggering (type B), housing color red
FMC-210-DM-G-B Form G, Blue	Manual Call Point for indoor use, indirect triggering (type B), housing color blue
FMC-210-DM-H-B Form H, Blue	Manual Call Point for outdoor use, indirect triggering (type B), housing color blue
FMC-210-DM-G-Y Form G, Yellow	Manual Call Point for indoor use, indirect triggering (type B), housing color yellow
FMC-210-EST-G-B Form G, Blue	Electronic Stop Device for indoor use, indirect triggering (type B), housing color blue



Notice

The key must be ordered separately.

Technical specifications

Electrical

Operating voltage	24 V DC (15 V DC . . . 33 V DC)
Current consumption	0.4 mA

Mechanics

Dimensions (W x H x D)	135 x 135 x 40 mm / 5.31 x 5.31 x 1.5 in.
Housing material	Plastic, ASA
Colors	Red, RAL 3001 Blue, RAL 5005 Yellow, RAL 1003
Weight	Approx. 235 g

Environmental Considerations

Protection class as per EN 60529	
• Form H (outdoor use)	IP 54
• Form G (indoor use)	IP 52
Norm	
• FMC-210-DM-G-R, FMC-210-DM-H-R	EN 54-11
• FMC-210-DM-G-Y, FMC-210-EST-G-B	EN 12094-3
Permissible operating temperature	
• Form H (outdoor use)	-25 °C . . . +70 °C / -13 °F . . . 158 °F
• Form G (indoor use)	-10 °C . . . +55 °C / 14 °F . . . 131 °F

Ordering information

FMC-210-DM-H-R Form H, Red

Manual call point for outdoor use, indirect alarm triggering (type B), for LSN improved
Order number **FMC-210-DM-H-R**

FMC-210-DM-G-B Form G, Blue

Manual call point for indoor use, indirect triggering (type B), for LSN improved
Order number **FMC-210-DM-G-B**

FMC-210-DM-H-B Form H, Blue

Manual call point for outdoor use, indirect triggering (type B), for LSN improved
Order number **FMC-210-DM-H-B**

FMC-210-DM-G-Y Form G, Yellow

Manual call point for indoor use, indirect triggering (type B), for LSN improved
Order number **FMC-210-DM-G-Y**

FMC-210-EST-G-B Form G, Blue

Electronic stop device for indoor use, indirect triggering (type B), for LSN improved
Order number **FMC-210-EST-G-B**

FMX-FSO-LSN Punched, Self-adhesive Foil Sets (Blank)

For the labeling field of manual call points of the Series FMC-210.

1 unit = 10 sheets

Order number **FMX-FSO-LSN**

FMC-FST-DE Printed Labeling Foils for the Upper Label Field

For yellow and blue manual call points of Series FMC-120 and FMC-210, 1 unit = 5 sheets

Order number **FMC-FST-DE**

FMC-SPGL-DEIL Spare Glasses

For manual call points of Series DM, DKM, SKM, FMC-120 and FMC-210.

1 unit = 5 spare glasses

Order number **FMC-SPGL-DEIL**

Accessories

FMC-210-DM-G-R Form G, Red

Manual call point for indoor use, indirect alarm triggering (type B), for LSN improved







Order number **FMC-210-DM-G-R**

Key for Fire Detectors Types G and H

made of red plastic (ASA)

Order number **FMM-KEY-Form G/H**

FMC-210-DM Double Action Call Points

	FMC-210-DM-G-R Form G, Red	FMC-210-DM-H-R Form H, Red	FMC-210-DM-G-B Form G, Blue
			
Range of use	indoor	outdoor	indoor
Mounting	surface-mounted/flush-mounted	surface-mounted/flush-mounted	surface-mounted/flush-mounted
Operating voltage	15 V DC ... 33 V DC	15 V DC ... 33 V DC	15 V DC ... 33 V DC
Current consumption	0.4 mA	0.4 mA	0.4 mA
Protection category	IP 52	IP 54	IP 52
Permissible operating temperature	-10°C ... +55°C	-25°C ... +70°C	-10°C ... +55°C
Color	red, RAL 3001	red, RAL 3001	blue, RAL 5005
	FMC-210-DM-H-B Form H, Blue	FMC-210-DM-G-Y Form G, Yellow	FMC-210-EST-G-B Form G, Blue
			
Range of use	outdoor	indoor	indoor
Mounting	surface-mounted/flush-mounted	surface-mounted/flush-mounted	surface-mounted/flush-mounted
Operating voltage	15 V DC ... 33 V DC	15 V DC ... 33 V DC	15 V DC ... 33 V DC
Current consumption	0.4 mA	0.4 mA	0.4 mA
Protection category	IP 54	IP 52	IP 52
Permissible operating temperature	-25°C ... +70°C	-10°C ... +55°C	-10°C ... +55°C
Color	blue, RAL 5005	yellow, RAL 1003	blue, RAL 5005

Represented by:

Americas:

Bosch Security Systems, Inc.
130 Perinton Parkway
Fairport, New York, 14450, USA
Phone: +1 800 289 0096
Fax: +1 585 223 9180
security.sales@us.bosch.com
www.boschsecurity.us

Europe, Middle East, Africa:

Bosch Security Systems B.V.
P.O. Box 80002
5617 BA Eindhoven, The Netherlands
Phone: + 31 40 2577 284
Fax: +31 40 2577 330
emea.securitysystems@bosch.com
www.boschsecurity.com

Asia-Pacific:

Robert Bosch (SEA) Pte Ltd, Security Systems
11 Bishan Street 21
Singapore 573943
Phone: +65 6571 2808
Fax: +65 6571 2699
apr.securitysystems@bosch.com
www.boschsecurity.asia

China:

Bosch (Shanghai) Security Systems Ltd.
201 Building, No. 333 Fuquan Road
North IBP
Changning District, Shanghai
200335 China
Phone +86 21 22181111
Fax: +86 21 22182398
www.boschsecurity.com.cn

America Latina:

Robert Bosch Ltda Security Systems Division
Via Anhanguera, Km 98
CEP 13065-900
Campinas, Sao Paulo, Brazil
Phone: +55 19 2103 2860
Fax: +55 19 2103 2862
al.securitysystems@bosch.com
www.boschsecurity.com