

PTZ Dome Cameras Mounts

HDZNPTA/HDZJB/HDZWM1/HDZWM2/
HDZCM1/HDZCM2/HDZCM3/HDZCMA/
HDZPMA/HDZGM/HDZINPL/HDZINSM

Honeywell is taking quality and reliability to the next level with the line of mounts and accessories for the new HDZ PTZ cameras. The mounts can be used to install the new HDZ line of PTZ IP cameras to a variety of surfaces. The HDZ PTZ mounts can be used to install the 1080p IR IP PTZ domes in a number of installation scenarios, giving maximum flexibility for positioning the PTZ dome.

The simple, solid design of these mounts is an installer's first choice for ease of installation. All of the mounts provide easy cable routing and the PTZ domes can be installed, adjusted, and tested without repositioning the housing. The ceiling mount and extension poles all use a G1.5 thread for easy installation.

All the mounts feature die-cast aluminum or galvanized steel construction with an off-white powder coating finish that exactly matches the cameras' finish.

Market Opportunities

Honeywell's new line of mounts and accessories for the HDZ IP PTZ domes provide performance and strength you can depend on. The attractive design, impact-resistant construction, and range of mounting options make these mounts the best solution for all of your indoor and outdoor PTZ dome applications.



HDZPMA



HDZCM1



HDZCMA



HDZCM2



HDZWM1



HDZCM3



HDZWM2



HDZGM



HDZJB



HDZINPL



HDZNPTA



HDZINSM

FEATURES & BENEFITS

FEATURES	LOW PROFILE, CONTEMPORARY DESIGN	ECONOMICALLY PRICED	EASY CABLE FEED-THROUGH	CONCEALED WIRING	DIE-CAST ALUMINUM CONSTRUCTION	SECC CONSTRUCTION	OFF-WHITE POWDER FINISH	INDOOR/ OUTDOOR
HDZCMA	✓	✓	✓	✓		✓	✓	✓
HDZPMA	✓	✓	✓	✓		✓	✓	✓
HDZCM1	✓	✓	✓	✓	✓		✓	✓
HDZCM2	✓	✓	✓	✓	✓		✓	✓
HDZCM3	✓	✓	✓	✓	✓		✓	✓
HDZJB	✓	✓	✓	✓	✓		✓	✓
HDZWM1	✓	✓	✓	✓	✓		✓	✓
HDZWM2	✓	✓	✓	✓	✓		✓	✓
HDZGM	✓	✓	✓	✓	✓		✓	✓
HDZNPTA	✓	✓	✓	✓	✓	✓	✓	✓
HDZINSM	✓	✓	✓	✓				
HDZINPL	✓	✓	✓	✓		✓	✓	

PTZ Dome Cameras Mounts Dimensions

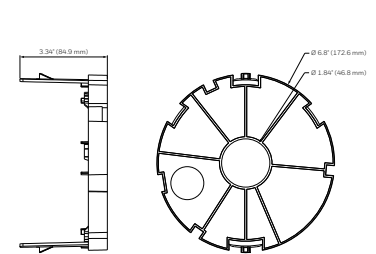
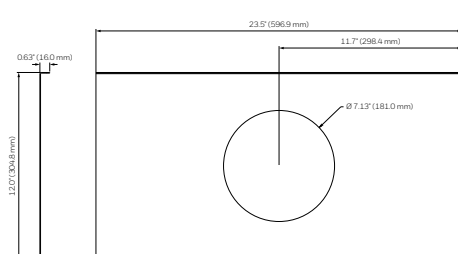
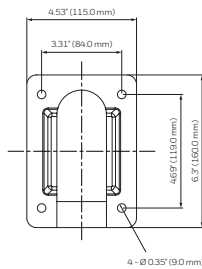
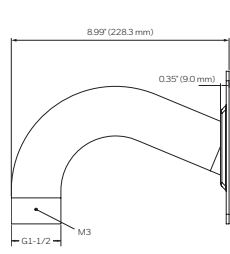
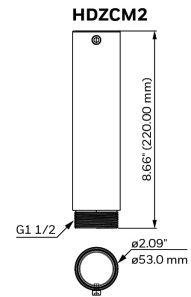
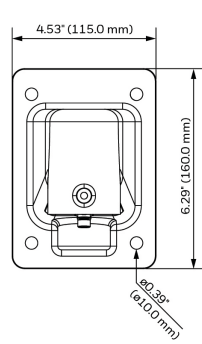
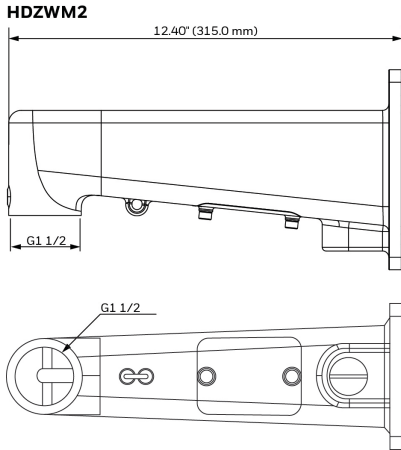
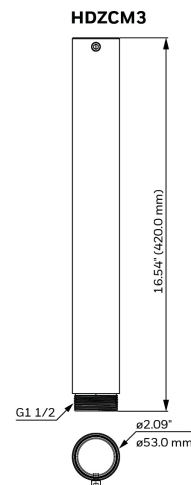
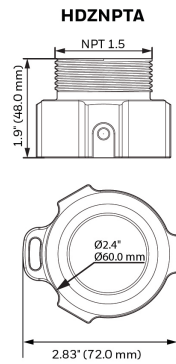
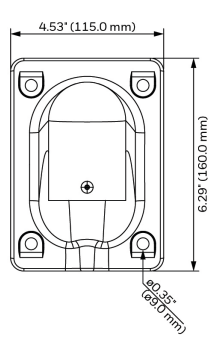
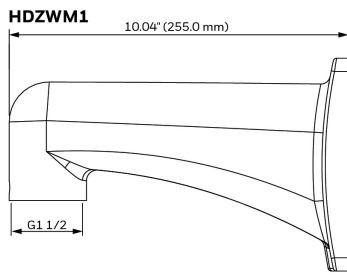
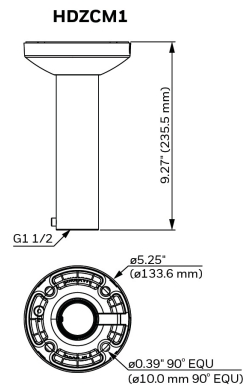
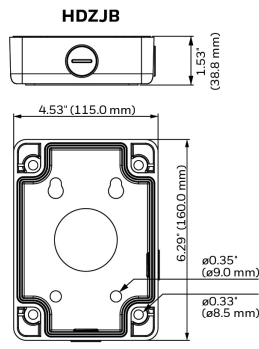
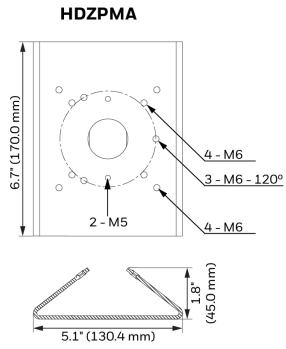
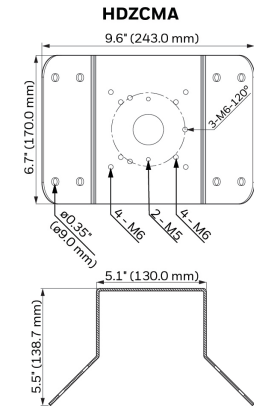

HDZGM

HDZINPL

HDZINSM

PTZ Dome Cameras Mounts Technical Specifications

MECHANICAL			
MODEL NO.	WEIGHT	CONSTRUCTION/ FINISH	DIMENSIONS
HDZPMA	2.05 lb. (0.93 kg)	SECC/White powder coating	5.1" x 6.7" x 1.8" (130.4 mm x 170.0 mm x 45.0 mm)
HDZCMA	3.7 lb. (1.7 kg)	SECC/White powder coating	6.7" x 9.6" x 5.4" (170.0 mm x 243.0 mm x 138.0 mm)
HDZCM1	1.72 lb. (0.78 kg)	Die-cast aluminum + polycarbonate/White powder coating	9.27" x Ø5.26" (235.5 mm x Ø133.6 mm)
HDZCM2	1.12 lb. (0.51 kg)	Die-cast aluminum/White powder coating	8.7" x Ø2.1" (220.0 mm x Ø53.0 mm)
HDZCM3	2.29 lb. (1.04 kg)	Die-cast aluminum/White powder coating	16.5" x Ø2.1" (420.0 mm x Ø53.0 mm)
HDZWM1	1.46 lb. (0.66 kg)	Die-cast aluminum/White powder coating	10.0" x 4.5" x 6.3" (255.0 mm x 115.0 mm x 160.0 mm)
HDZWM2	3.64 lb. (1.65 kg)	Die-cast aluminum/White powder coating	12.4" x 4.5" x 6.3" (315.2 mm x 115.0 mm x 160.0 mm)
HDZGM	1.08 lb. (0.49 kg)	Die-cast aluminum/White powder coating	8.99" x 4.53" x 6.3" (228.3 mm x 115.0 mm x 160.0 mm)
HDZJB	1.17 lb. (0.53 kg)	Die-cast aluminum/White powder coating	6.3" x 4.5" x 1.5" (160.0 mm x 115.0 mm x 38.8 mm)
HDZNPTA	0.5 lb. (0.23 kg)	Die-cast aluminum/White powder coating	1.9" x 2.8" (48.0 mm x 72.0 mm)
HDZINPL	3.0 lb. (1.36 kg)	SECC/White powder coating	0.63" x 23.5" x 12.0" (16.0 mm x 596.9 mm x 304.8 mm)
HDZINSM	0.36 lb. (0.165 kg)	Polyoxymethylene/Black finish (not visible when installed)	3.34" x Ø6.8" (84.9 mm x Ø172.6 mm)

INDOOR INSTALLATIONS	
PTZ Ceiling Mount	HDZ302LIW/HDZ302LIK/HDZ302D/HDZ302DE + HDZCM1
PTZ + 220 mm Extension Ceiling Mount	HDZ302LIW/HDZ302LIK/HDZ302D/HDZ302DE + HDZCM1 + HDZCM2
PTZ +420 mm Extension Ceiling Mount	HDZ302LIW/HDZ302LIK/HDZ302D/HDZ302DE + HDZCM1 + HDZCM3
OUTDOOR INSTALLATIONS	
PTZ Wall Mount	HDZ302LIW/HDZ302LIK/HDZ302D/HDZ302DE + HDZWM1/HDZWM2
	HDZ302D + HDZGM
PTZ Wall Mount with Junction Box	HDZ302LIW/HDZ302LIK/HDZ302D/HDZ302DE + HDZWM1/HDZWM2 + HDZJB
	HDZ302D + HDZGM + HDZJB
PTZ Pole Mount	HDZ302LIW/HDZ302LIK/HDZ302D/HDZ302DE + HDZWM1/HDZWM2 + HDZJB + HDZPMA
	HDZ302D + HDZGM + HDZJB + HDZPMA
PTZ Corner Mount	HDZ302LIW/HDZ302LIK/HDZ302D/HDZ302DE + HDZWM1/HDZWM2 + HDZJB + HDZCMA
	HDZ302D + HDZGM + HDZJB + HDZCMA

ORDERING

HDZCM1	PTZ Ceiling Mount	HDZJB	PTZ Junction Box
HDZCM2	Ceiling Mount Extension Pole for HDZCM1, 220 mm	HDZWM2	PTZ Wall Mount with Access Hole
HDZCM3	Ceiling Mount Extension Pole for HDZCM1, 420 mm	HDZNPTA	1.5" NPT Adapter
HDZWM1	PTZ Wall Mount	HDZGM	PTZ Gooseneck Wall Mount
HDZCMA	PTZ Corner Mount Adapter for Wall Mount	HDZINPL	PTZ In-Ceiling Support Plate (Drop Ceiling)
HDZPMA	PTZ Pole Mount Adapter for Wall Mount	HDZINSM	PTZ In-Ceiling Snap Mount (used with HDZINKIT for old in-ceiling back can housings)

For more information

www.honeywell.com/security

Honeywell Security and Fire

2700 Blankenbaker Pkwy, Suite 150

Louisville, KY 40299

1.800.323.4576

www.honeywell.com

L/PTZDCMTD/D | 01/17
© 2016 Honeywell International Inc.

Honeywell